



- 01 -    - 02 -    - 03 -    - 04 -    - 05 -    - 06 -    - 07 -    - 08 -

## Pumps

• End Suction Centrifugal Pump



## HISTORY

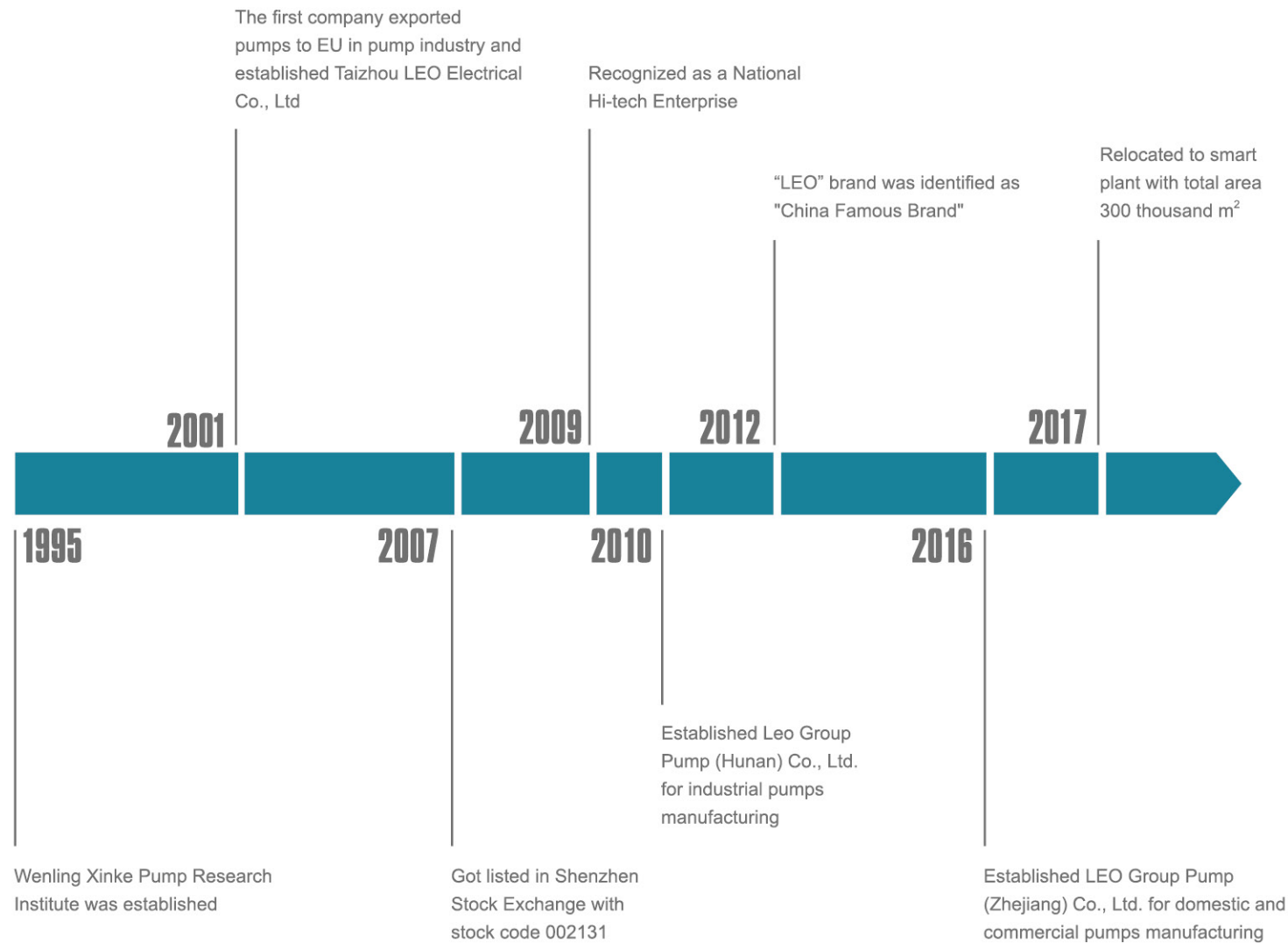

## TO KNOW LEO

LEO Group (got listed in Shenzhen Stock Exchange with stock code 002131) is a national high-tech enterprise engaged in R&D, design, manufacture, sales and service of all series pumps and systems. LEO is the first listed company in Chinese pump industry, one of the drafters of pump industry standard and the vice president of drainage and irrigation machinery branch of China Agricultural machinery industry association as well. "LEO" has been identified as "China Famous Brand" by the State Administration of Industry and Commerce. It is mentionable that LEO has the only state-authorized technical center in pump industry.

We have set up many production and sales subsidiaries in key regional markets such as America, Hungary, Belgium, Thailand, Indonesia, United Arab Emirates and Bangladesh and authorized exclusive distribution agency in over 100 countries.

Our products have been sold to over 120 countries and regions, such as Europe, North America, Central & South America, Southeast Asia, Middle East, Africa, Oceania, etc., which play a crucial role in water conservancy, water resources, electric power construction, petrochemical industry, mining, metallurgy, fire-fighting, HVAC (Heating, Ventilation and Air Conditioning), agricultural irrigation, civil water supply and drainage, etc.

LEO has currently two industrial groups respectively for industrial and civilian applications. With four manufacturing bases in Wengling of Zhejiang, Xiangtan of Hunan, Wuxi of Jiangsu and Dalian of Liaoning, LEO possesses a solid foundation to become a world-class pump and system solution provider rapidly.

With over 70 years' professional technology, LEO will continue her consistent creativity and development ability in each pump for human's health.



## NUMEROUS MEMBERS, ONE FAMILY

Based on market segment, LEO's pump business is divided into 5 fields, namely water conservancy & water resources, power station, petrochemical industry, mining & metallurgical industry and civilian applications. For each field there's a professional manufacturing base with relevant professional sales teams. Three subsidiary companies, Wuxi LEO Xi Pump, LEO Group Pump (Hunan) and Dalian LEO Pump are all well-known industrial pump manufacturers in their own fields. With over 70 years' industrial pump manufacturing experience and extraordinary comprehensive strength, LEO has become a leading company among all industrial pump manufacturers in China.



### Pump Manufacturing Base for Domestic and Commercial Applications (Wenling City, Zhejiang Province)

LEO Group Pump (Zhejiang) Co., Ltd, a wholly-owned subsidiary of LEO Group Co., Ltd, is the core base for R&D, manufacturing, sales and service of domestic and commercial pumps for family water supply, pipeline boosting, garden and field irrigation, HVAC, etc.

The leading products include peripheral pump, jet pump, centrifugal pump, garden submersible pump, fountain pump, pool pump, doestic lifting station, gasoline engine pump, diesel engine pump, submersible pump, submersible borehole pump, submersible sewage pump, stainless steel vertical multistage pump, etc.

The product range covers 15 series with over 2,000 specifications, which are well sold in more than 120 countries and regions. The base has established steady cooperative relationships with world-class pump manufacturers, importers, dealers and hypermarkets.



### Pump Manufacturing Base for General Industrial Pumps (Xiangtan City, Hunan Province)

Established in 2010, LEO Group Pump (Hunan) Co., Ltd. is a wholly-owned subsidiary by LEO Group Co., Ltd. Located in Jiuhua Economic Development Zone of Xiangtan City, Hunan Province. Covers an area of 85,000m<sup>2</sup> and construction area is about 92,635 m<sup>2</sup> with total investment of approximately 74 million dollars. It is the most important R&D, manufacturing and testing center of LEO Group. The leading products include large mixed flow and axial flow pump (vertical, horizontal, oblique, tubular, submersible etc.), double-suction centrifugal pump, multistage centrifugal pump, slurry pump, desulphurization pump and submersible centrifugal pump. Products are mainly used in mine, metallurgy, coal washing, FGD, municipal water etc.



### Pump Manufacturing Base for Water Conservancy & Water Resources (Wuxi City, Jiangsu Province)

Formerly known as Wuxi Xi Pump Manufacturing Co., Ltd., a well-known manufacturer of water conservancy, is specialized in large and medium-sized pumps production for urban water supply and drainage, farmland irrigation, water conservancy projects and large water diversion project. The main products cover 32 series with nearly 1000 specifications. Products exported to more than 20 countries in Asia, Latin-America, Europe and Oceania.

As a main supplier, the base provides large pumps for South-to-North Water Diversion Project—a national key project. There are over 140 technicians, including 1 professor level senior engineer, 16 senior engineers, and 39 engineers.



### Pump Manufacturing Base for Petrochemical Industry (Dalian City, Liaoning Province)

It is the pump manufacturing base for petrochemical industry, combined with Dalian LEO Huaneng Pump Co., Ltd and LEO (Dalian) Industrial Pump Technology Center Co., Ltd.

Formerly known as Dalian Huaneng Corrosion-Resistant Pump Works, the base is specialized in production of petrochemical pumps for crude oil transportation, crude oil refinery, heavy chemical industry, coal chemical industry and fine chemistry, etc. The base focuses on design and manufacture of 30 series (OH, BB, VS, etc.) of petrochemical pumps with over 3000 specifications, which are in accordance with API and ISO standard.

LEO (Dalian) Industrial Pump Technology Center Co., Ltd. is one of the research branch of national level technology center for petrochemical pumps, specializes in R&D , design of pumps of petro chemistry, coal chemical industry, long-distance transport pipes, energy resources, fine chemicals industry, etc. Design and develop software and large laboratories, explore liquid transport schemes under severe conditions and solve the difficult projects of ultralow temperature, high temperature, high pressure, low cavitation, highly corrosive, energy recovery, etc.

## Applications

- Water supply systems
- Pressure boosting
- Heating systems for commercial buildings and district heating
- Cooling plants for industrial processing and air-conditioning units
- General transport for industrial processes
- Fire fighting system

## Identification Codes

### LEP 50-32-130 H(G)/139

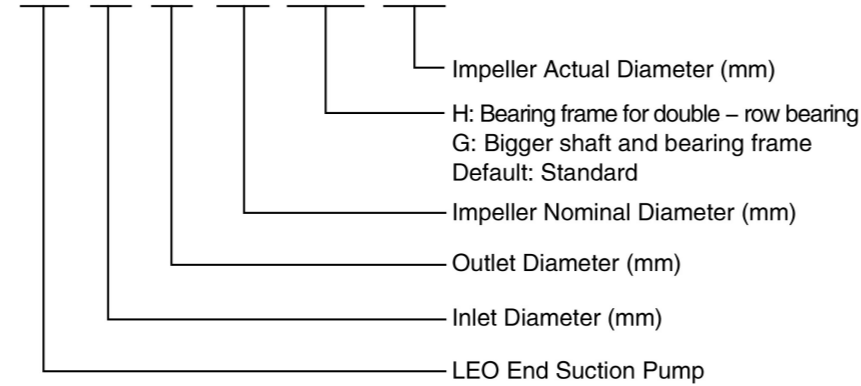

## Working Conditions

- Pump design complies to BS EN 733/DIN 24255 standard
- Conveying medium: Low viscosity, non-flammable and non-explosive liquids not containing solid particles or fibers
- Speed: 1450/2900 rpm at 50 Hz, 1750/3500 rpm at 60 Hz
- Flow range: 0.5 - 440 l/s
- Head range: 2 - 152 m
- Max. liquid temperature: 105°C
- Liquid pH value: 4 - 10
- Max. operation pressure: 10 bar, 16 bar on request

## Design & Structure

Design	Performance and dimensions referring to the European standard BS EN733/DIN24255
Structure	Horizontal, Axial End-Suction, Single-Stage, Single-Suction, Volute Casing, Back pull-out
DN(mm)	Inlet: 50-350 Outlet: 32-300
Flange	ISO7005.2 ; DIN2501 PN16 ; GB/T17241.6 PN1.6

## Materials Table

No.	Part	Material
1	Pump casing	Cast Iron Ductile Iron 304/316
2	Impeller nut	
3	Wear ring	
4	Impeller	Brass/Bronze Cast Iron 304/316
5	Casing cover	
6	Shaft spacer	
7	Mechanical seal	
8	Seal cover	
9	Rubber slinger	
10	Bearing frame	
11	Shaft	304/316/1045

No.	Part	Material
12	Bearing	
13	Bearing cover	
14	Support foot	
15	Packing sleeve	Bronze
16	Packing seal cage	
17	Gland packing	
18	Gland cover	
19	Casing gasket	
20	Nut	
21	Nut	
22	Nut	

No.	Part	Material
23	Key	
24	Key	
25	Bolt	
26	Oil nipple	
27	Oil seal	
28	Nut	
29	Washer	
30	Washer	
31	Oil scale	
32	Oil cover	
33	Bearing Cover Gasket	

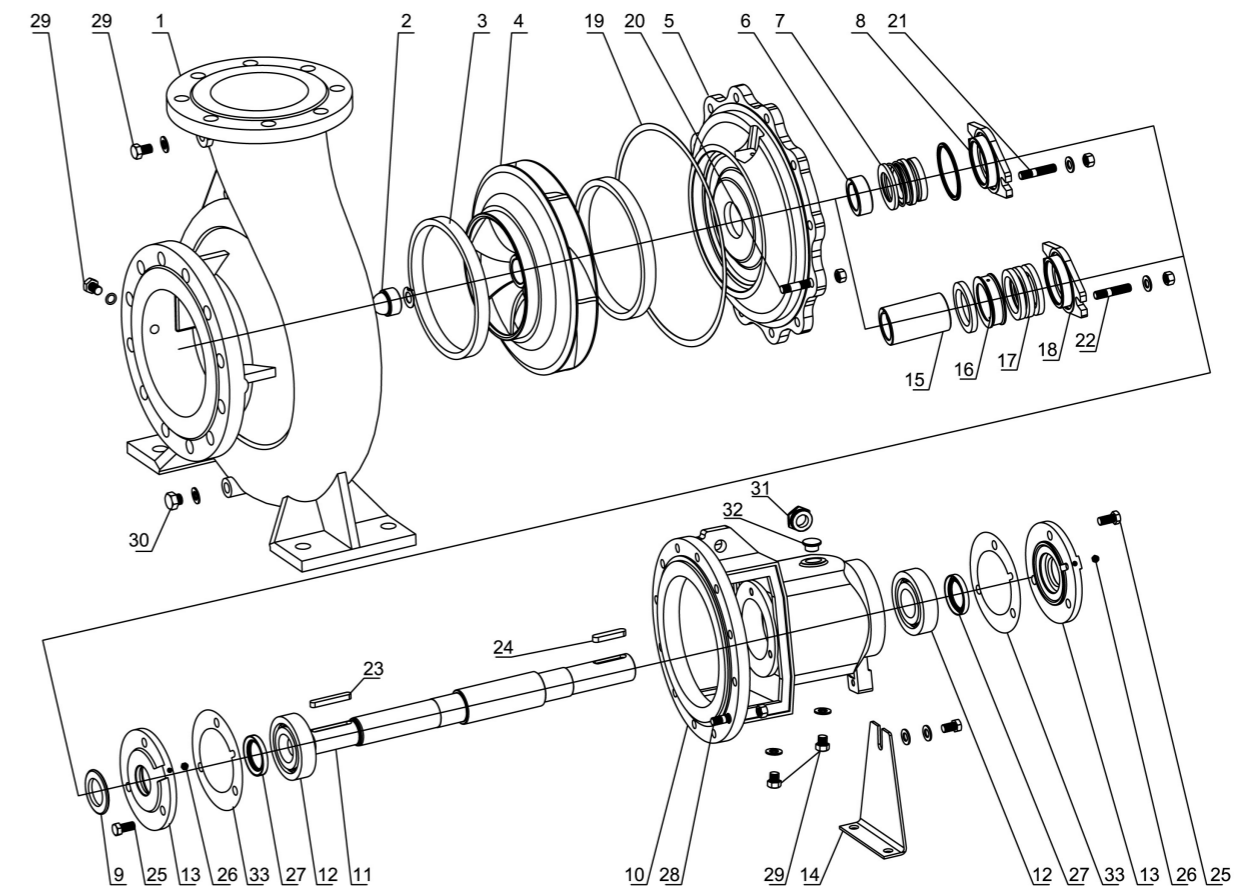

**Characteristic Curves**

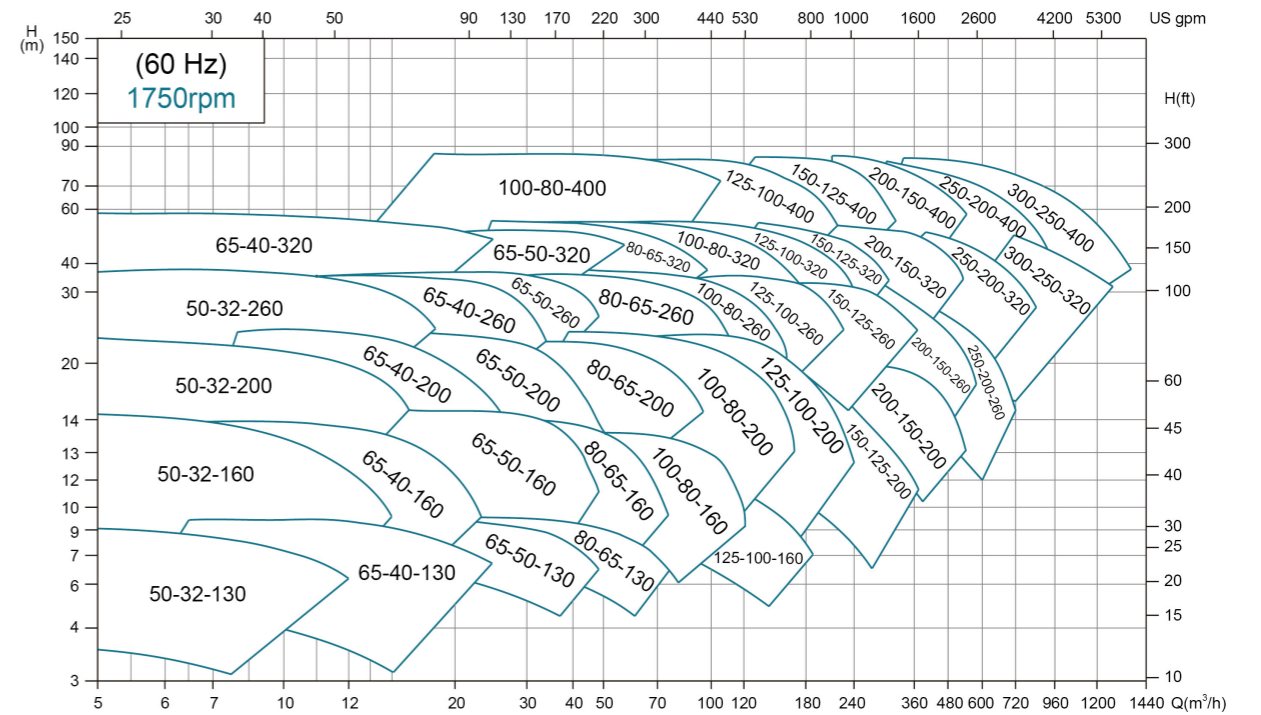
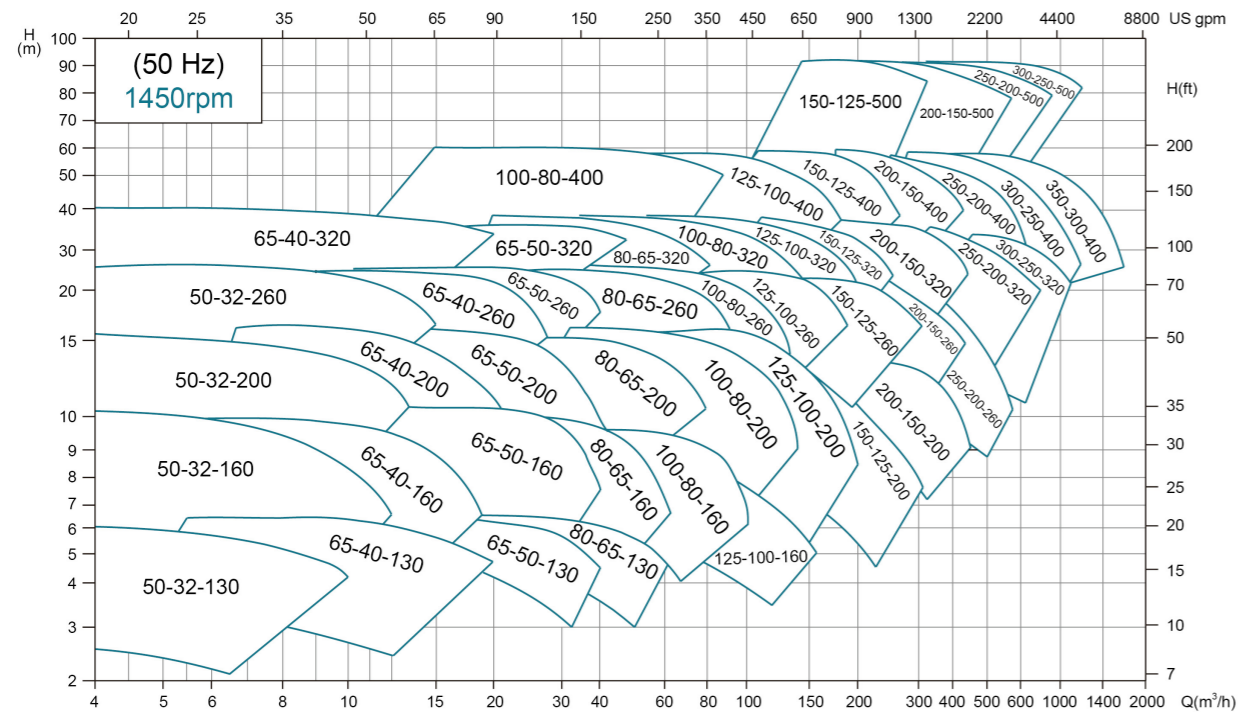
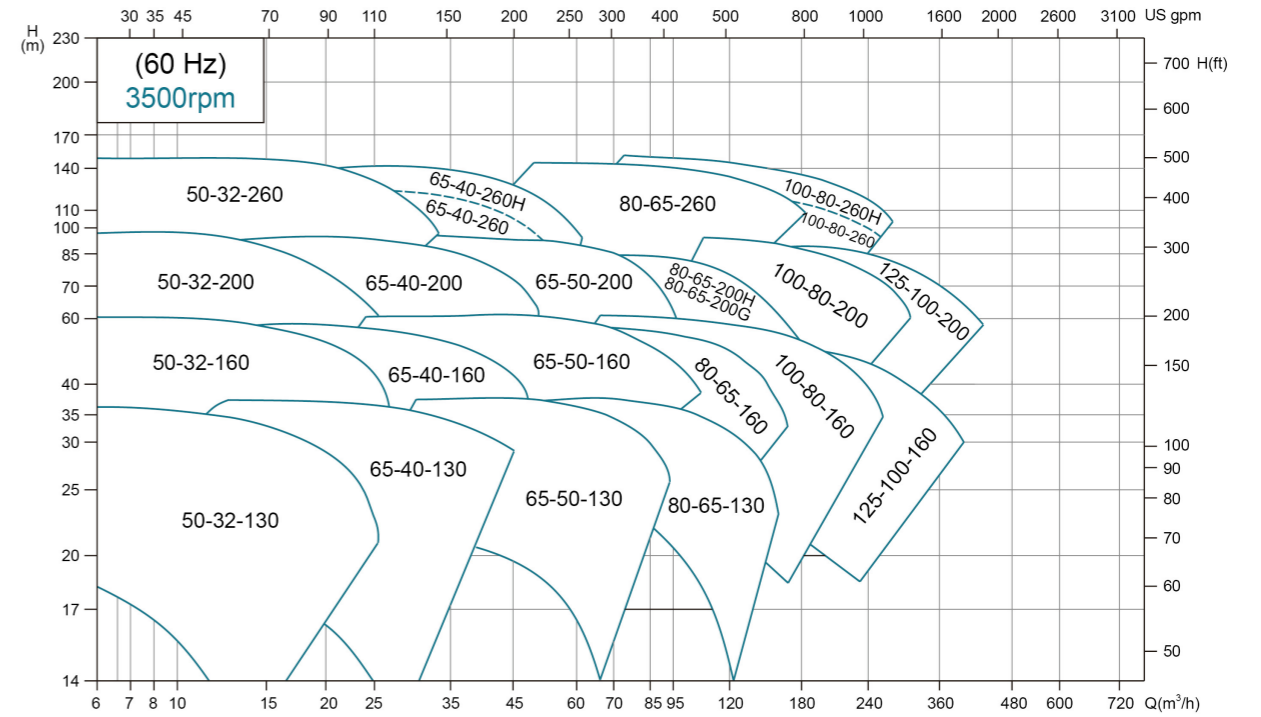
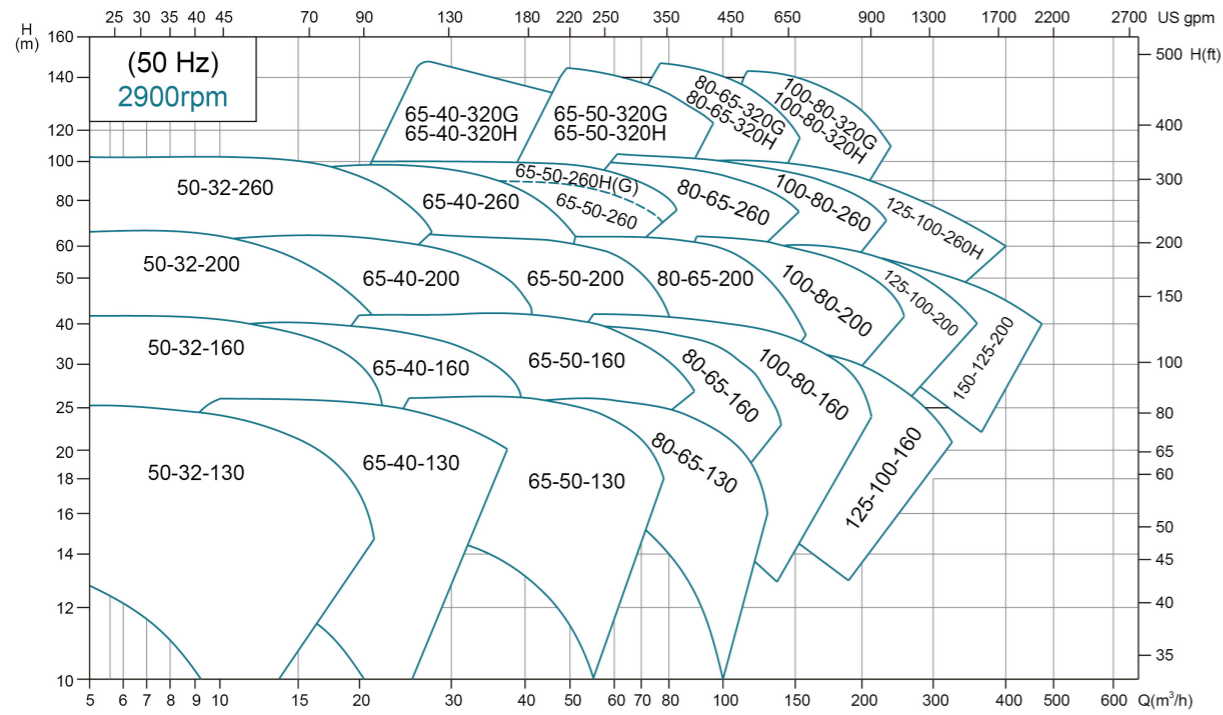



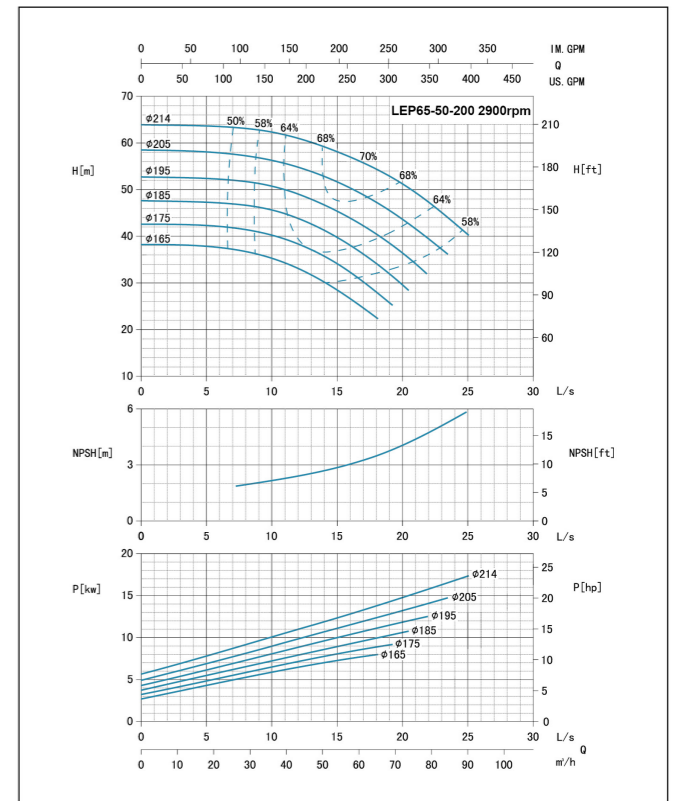
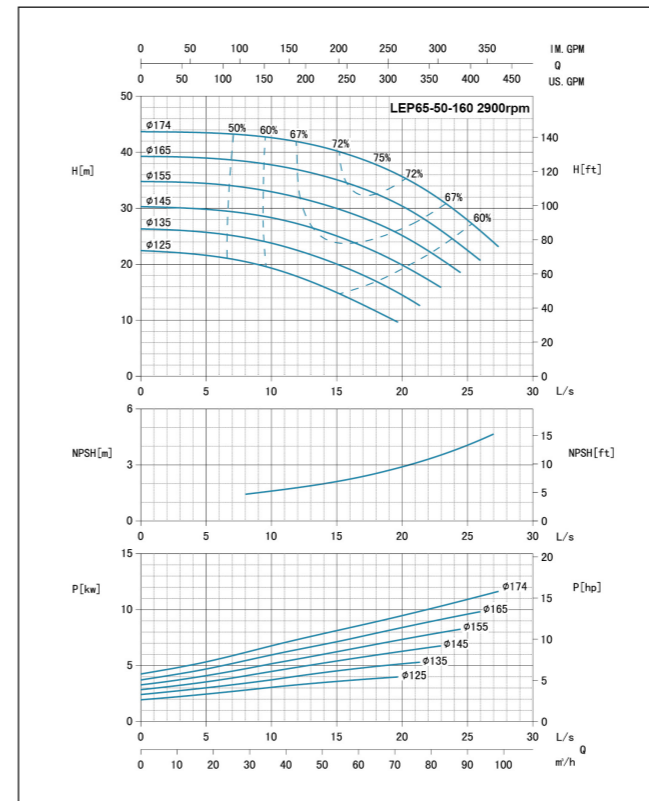
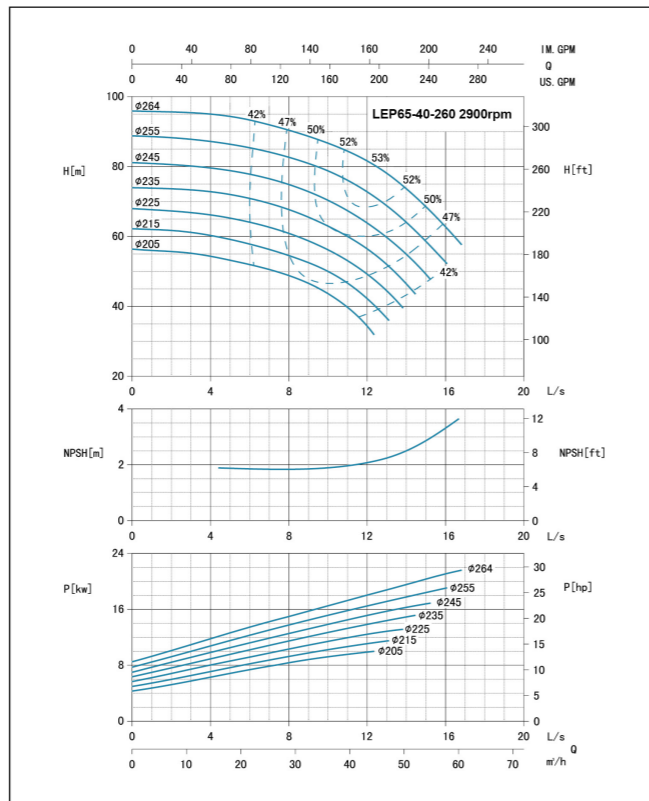
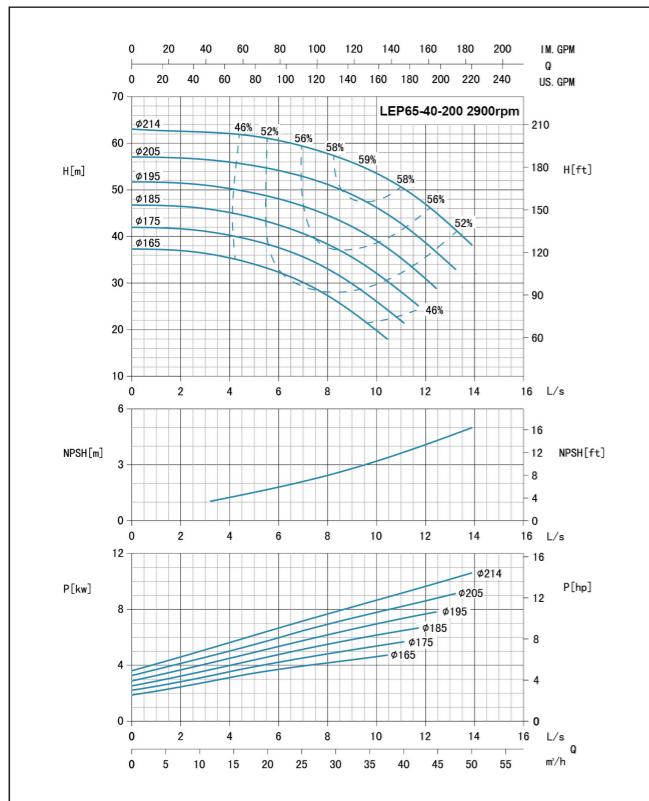
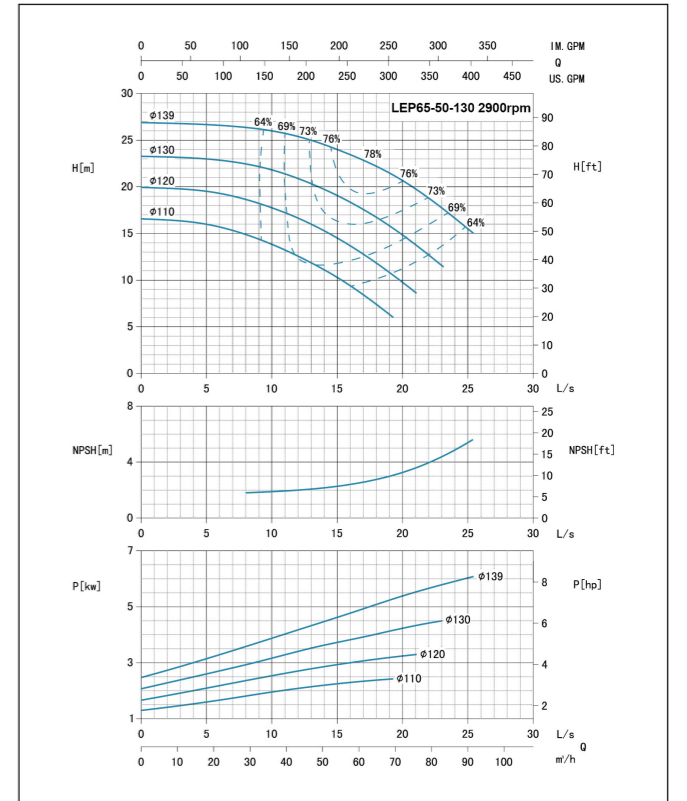
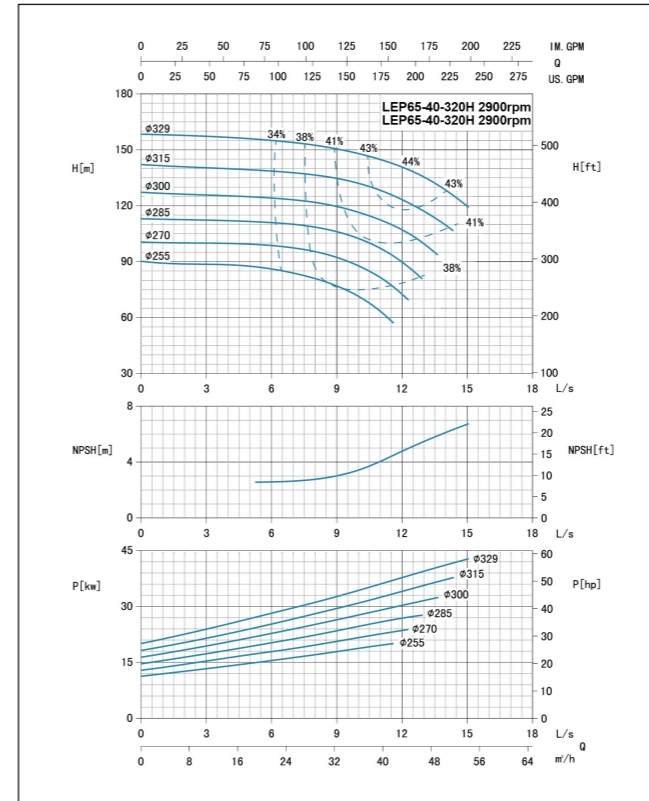
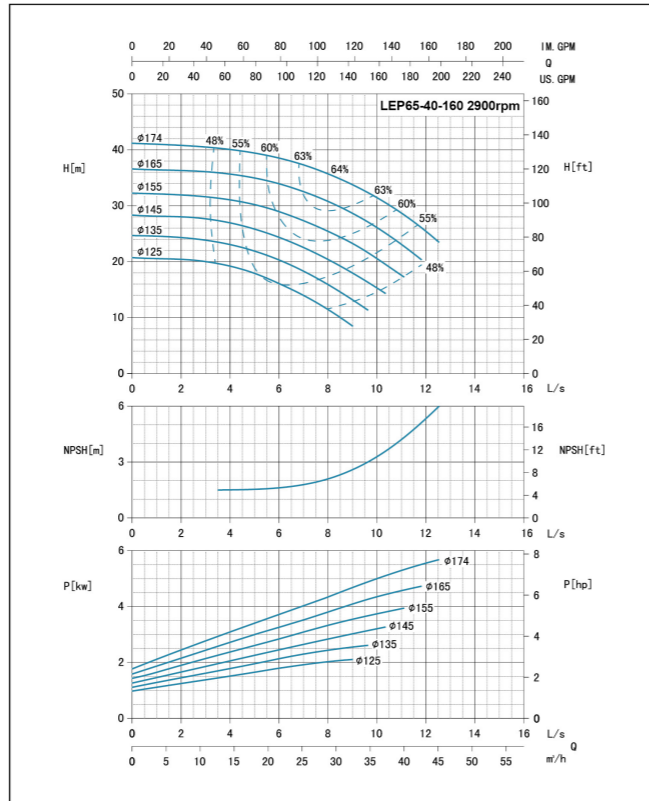
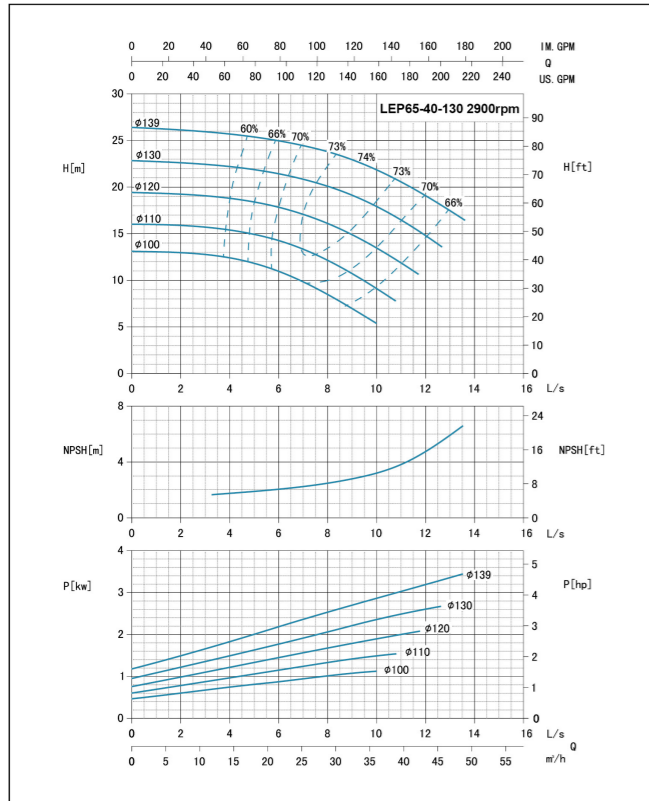

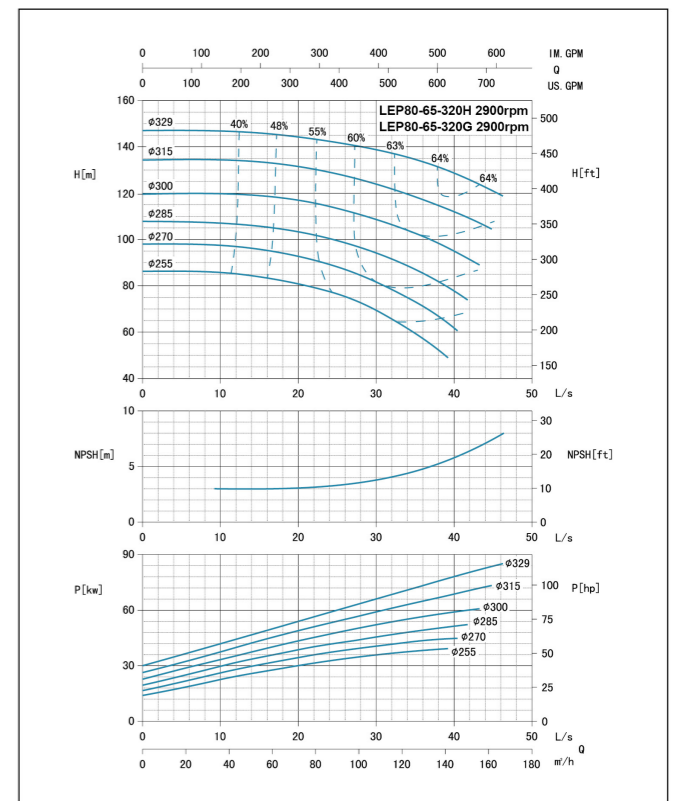
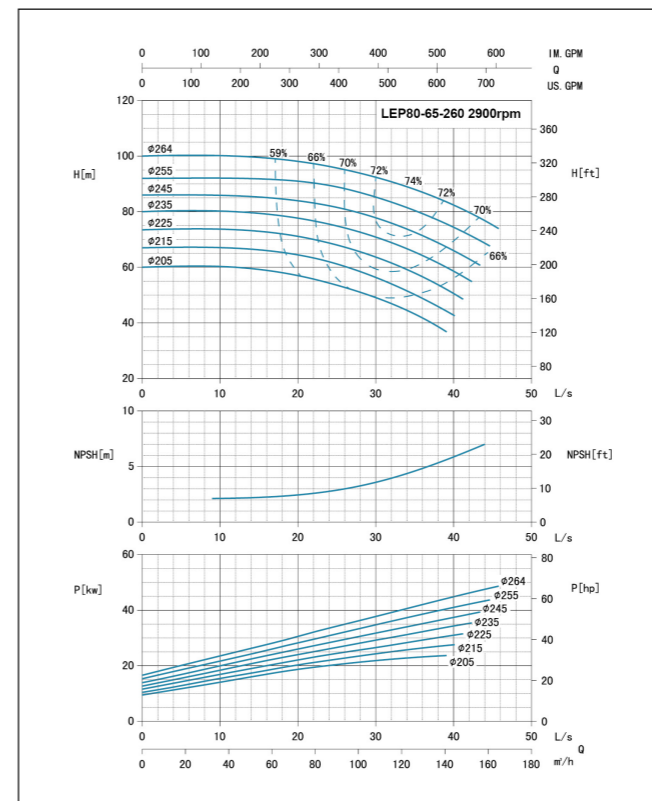
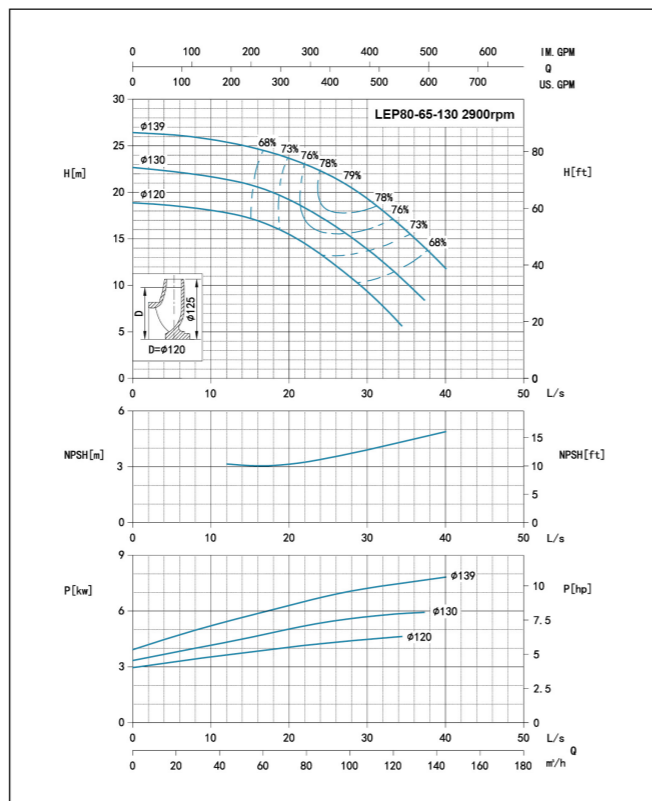
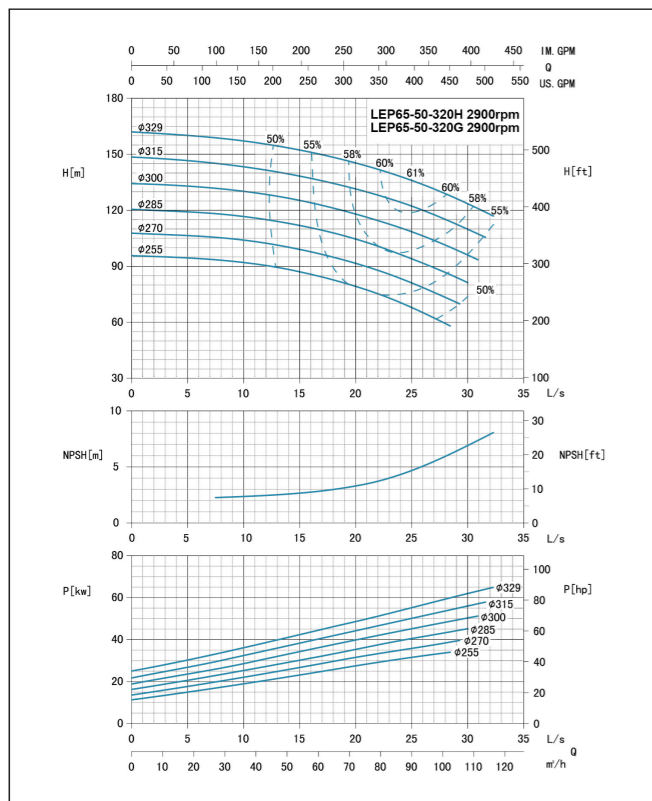
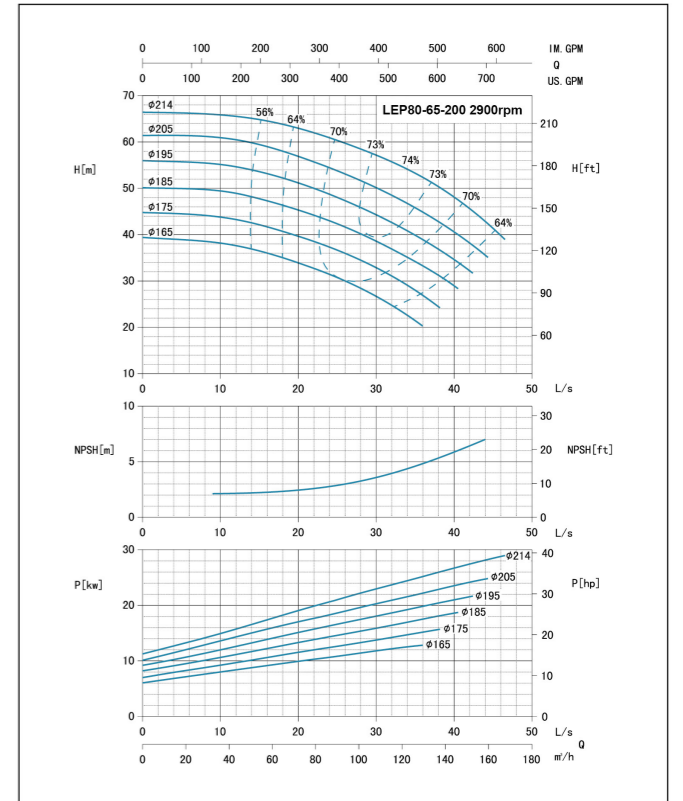
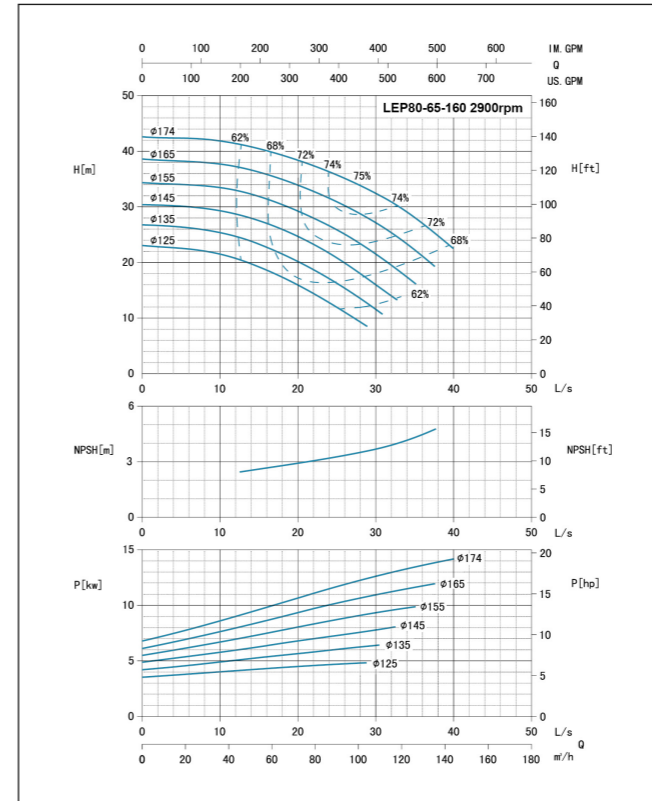
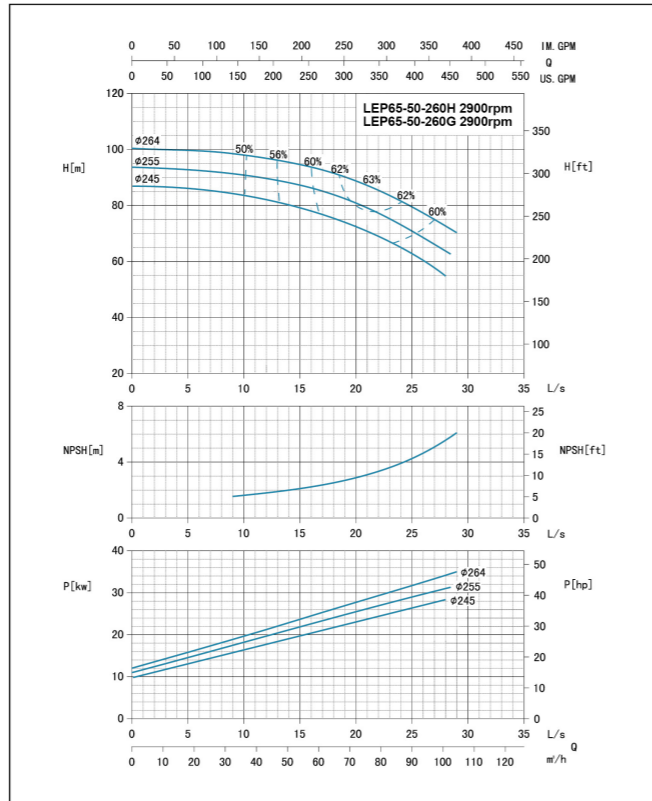
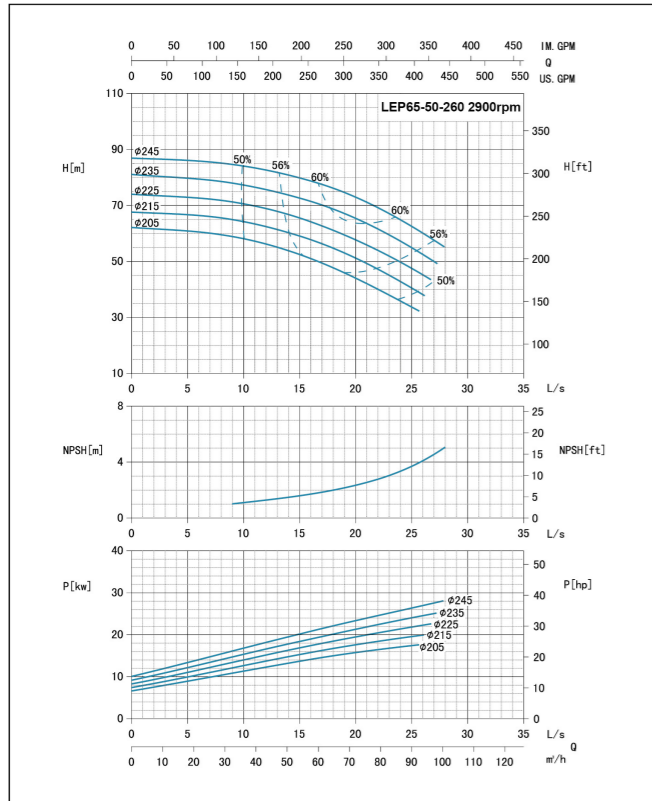



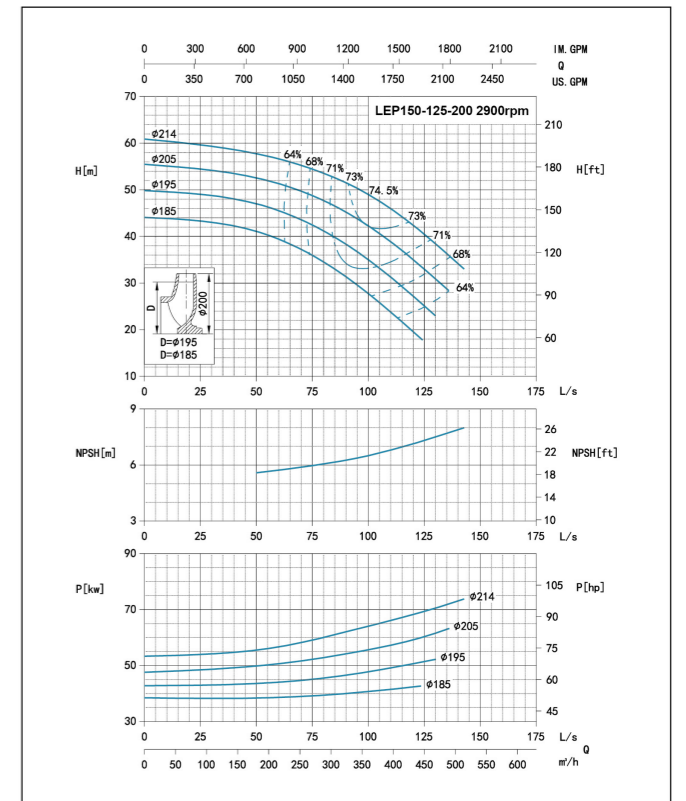
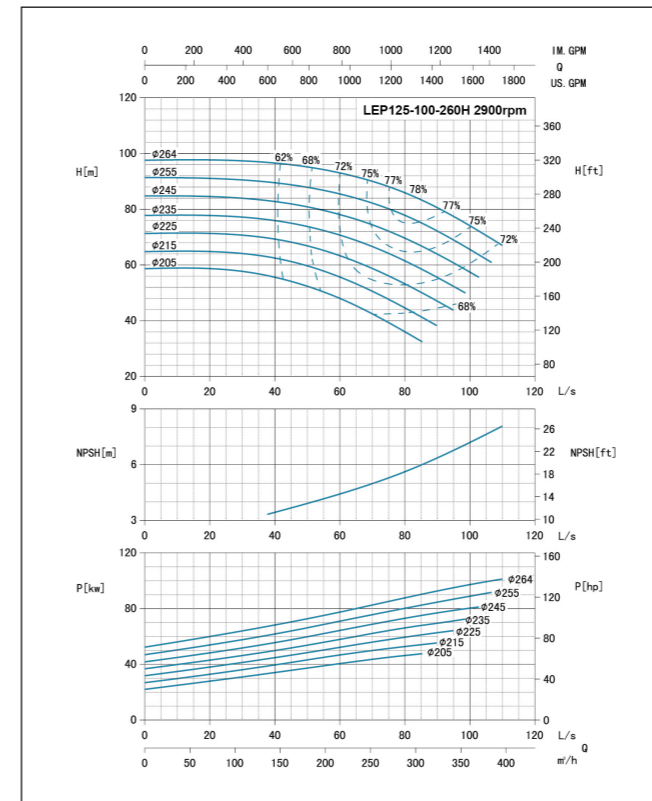
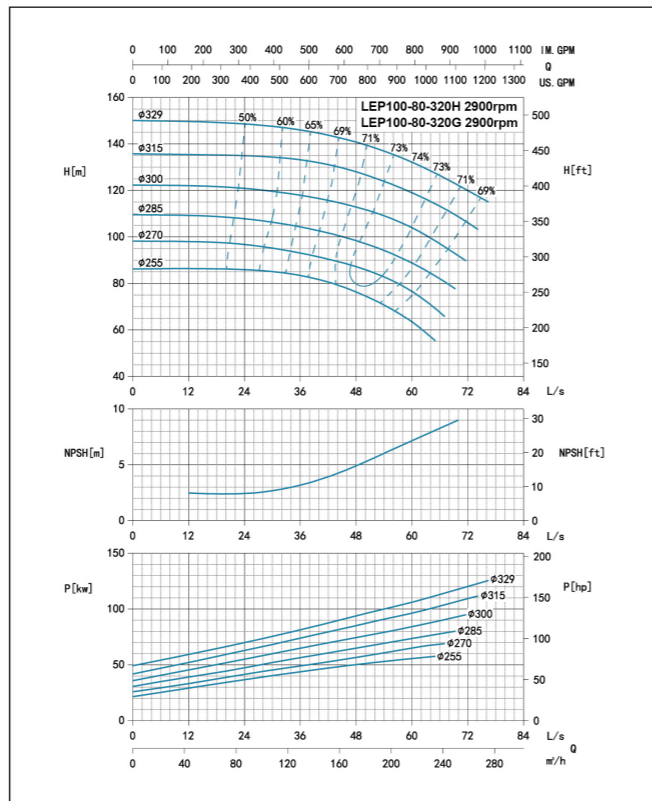
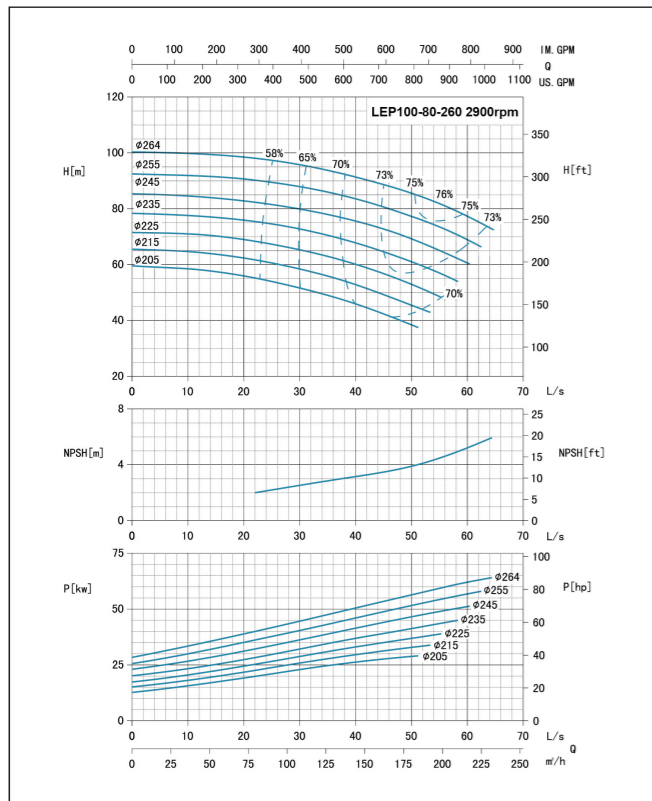
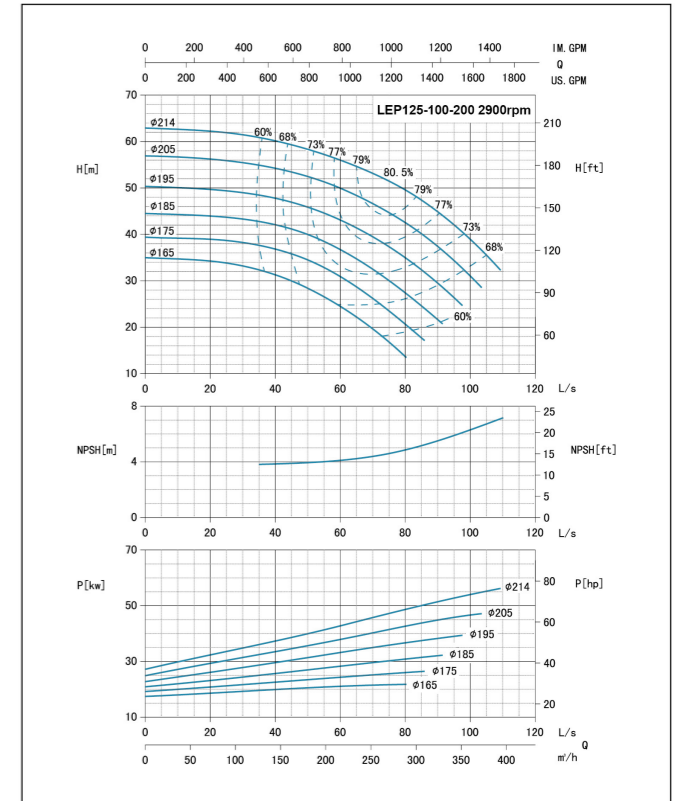
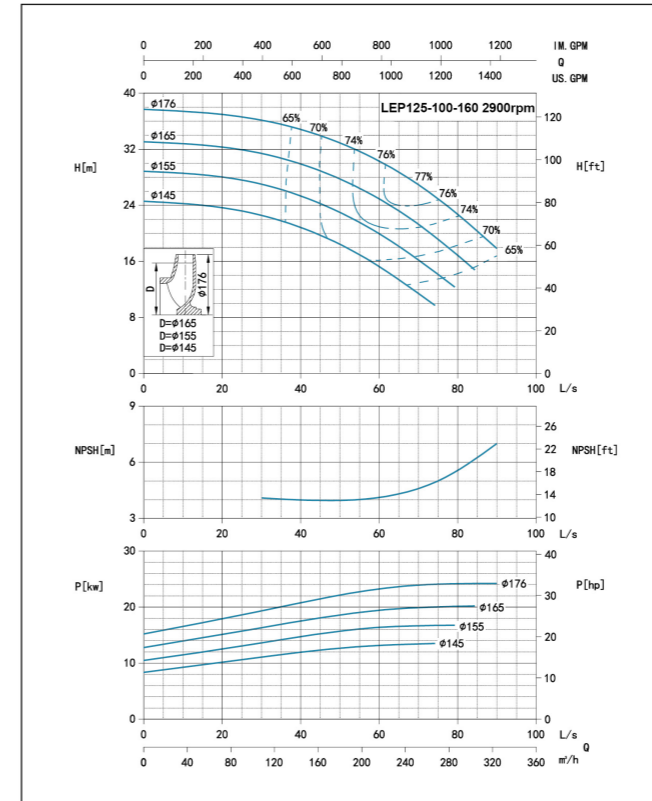
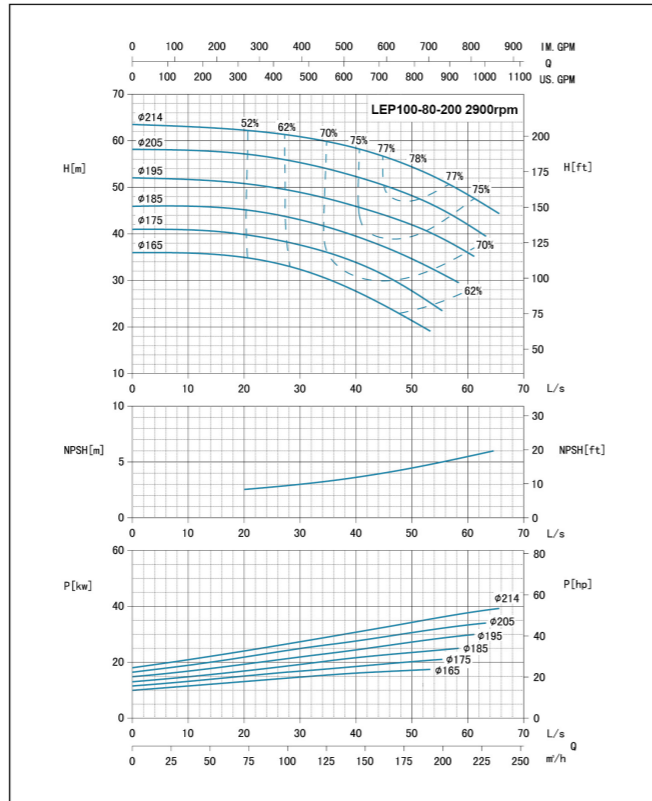
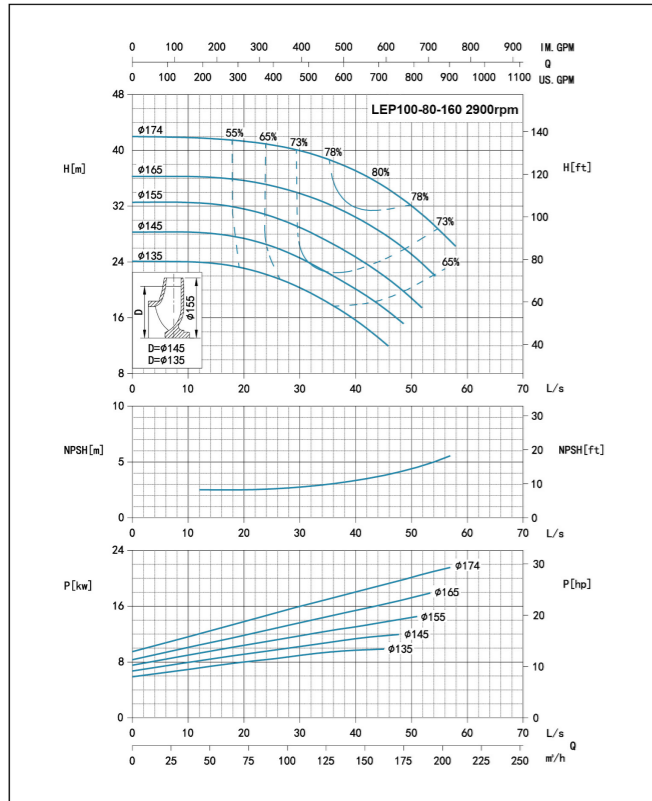

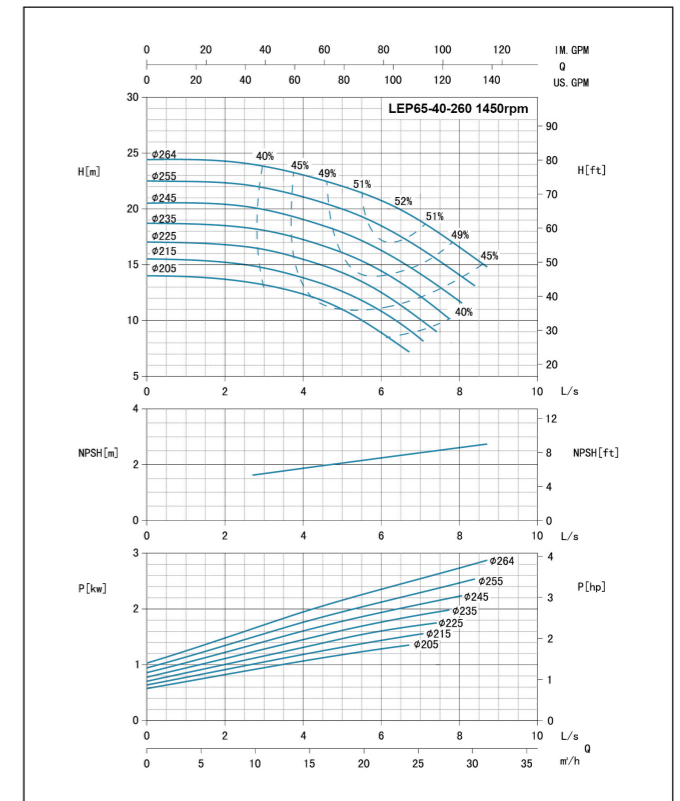
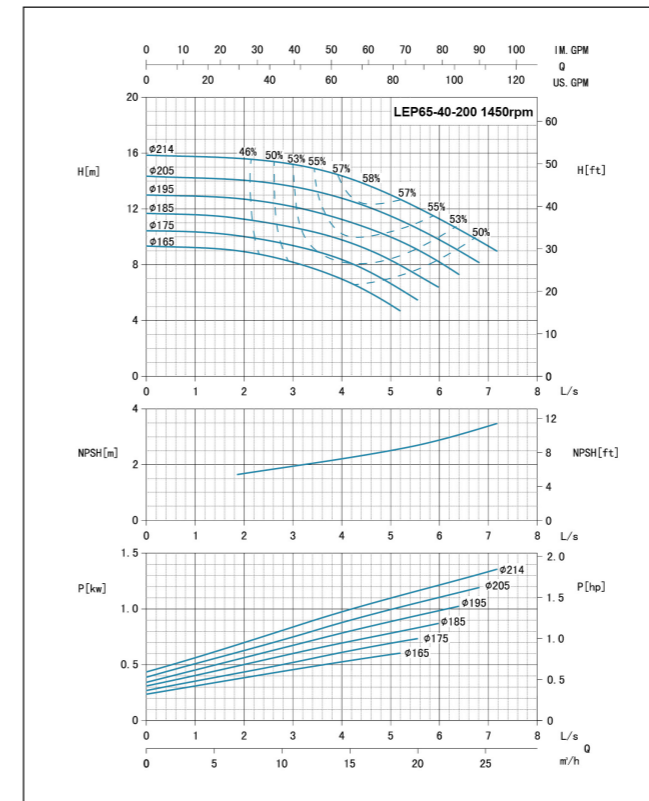
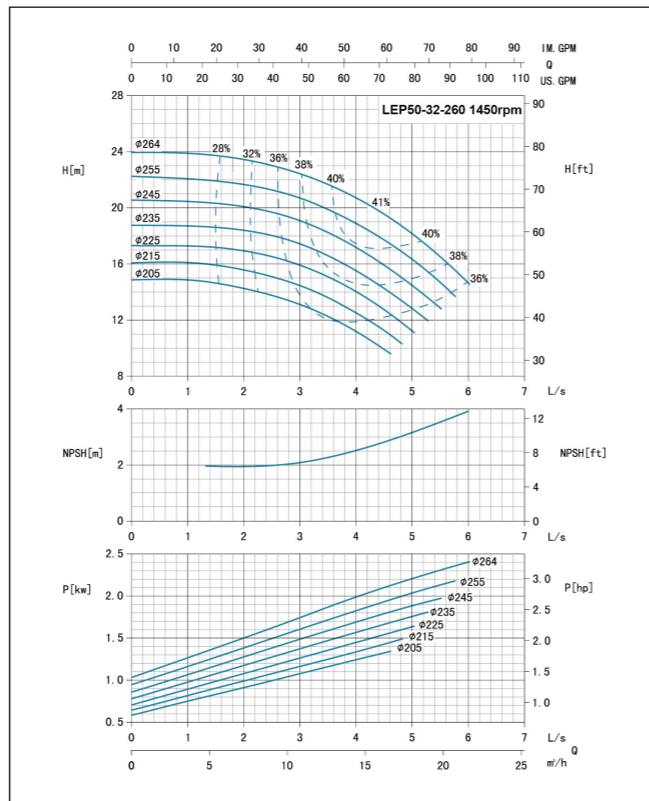
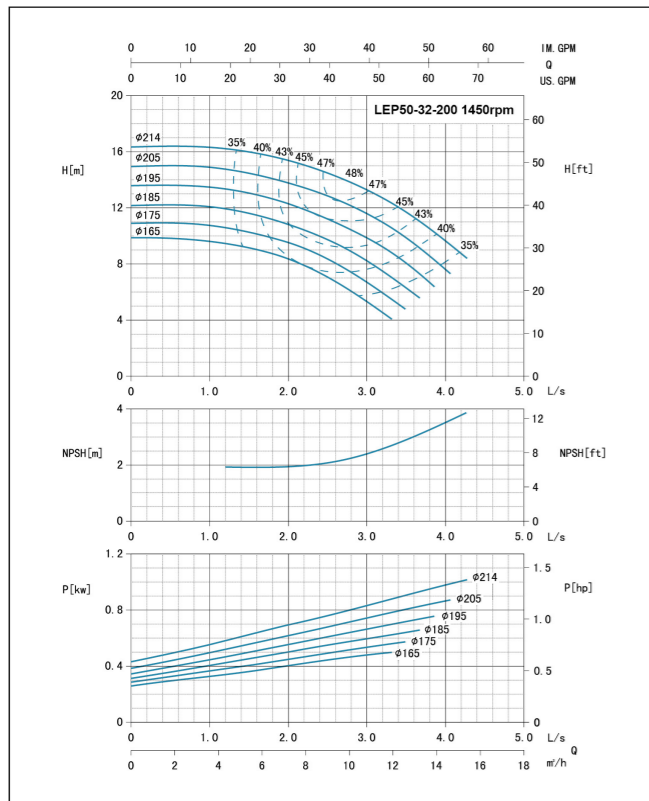
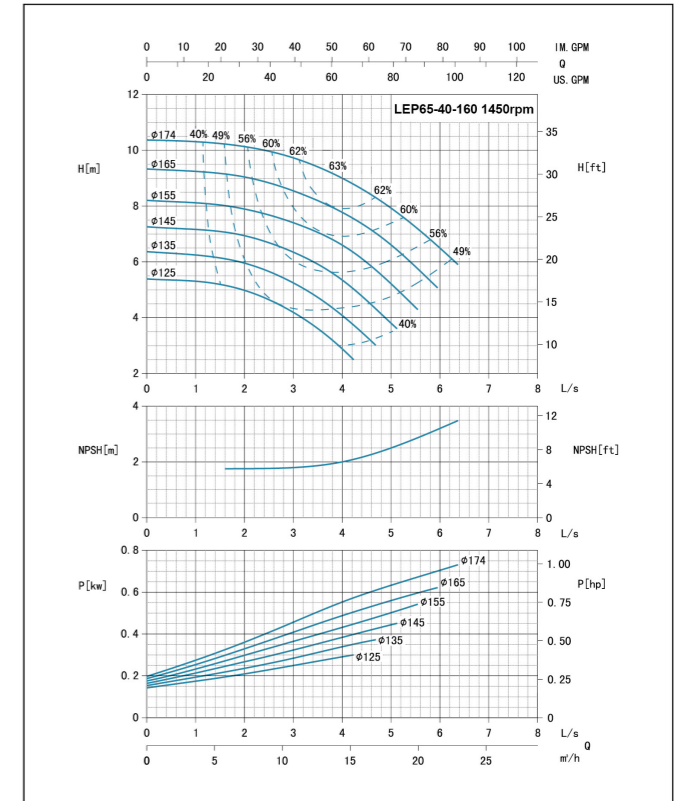
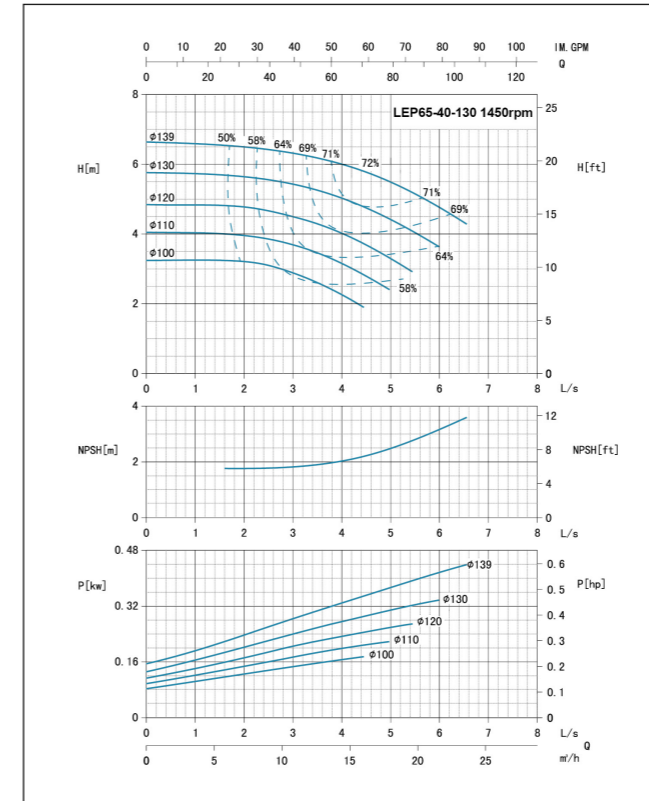
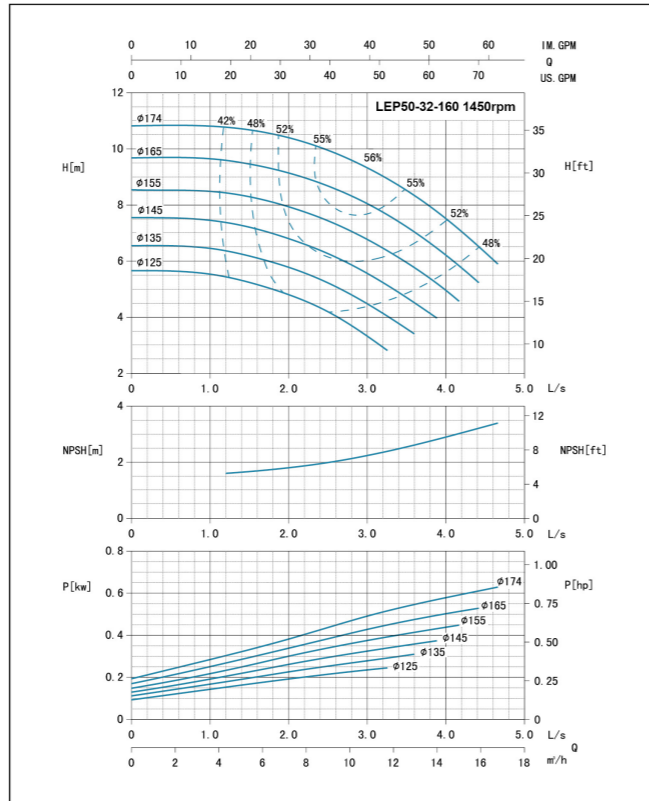
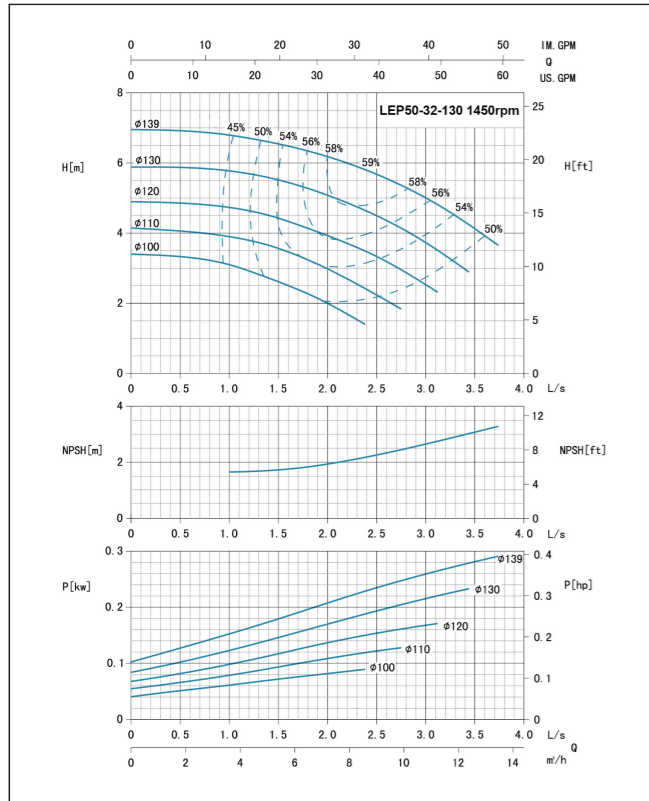

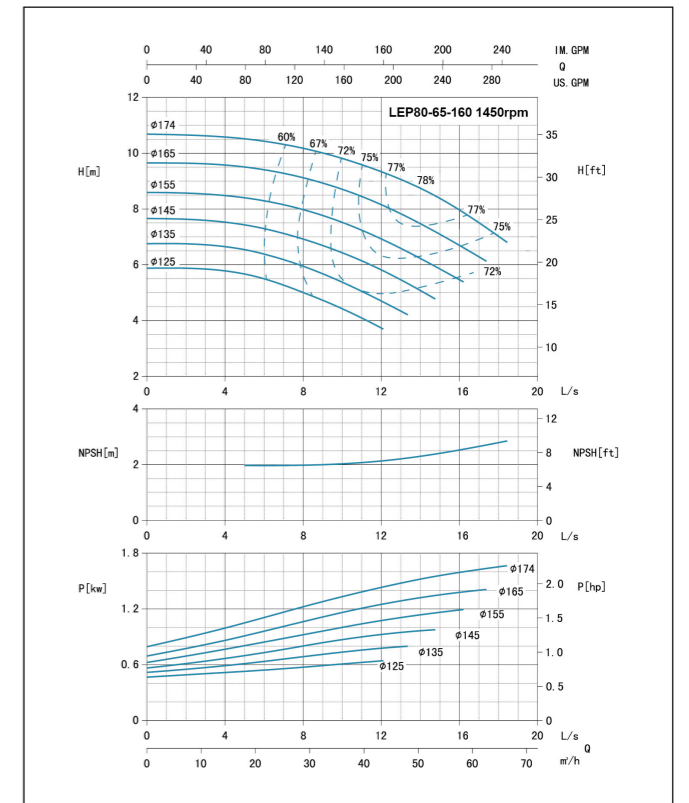
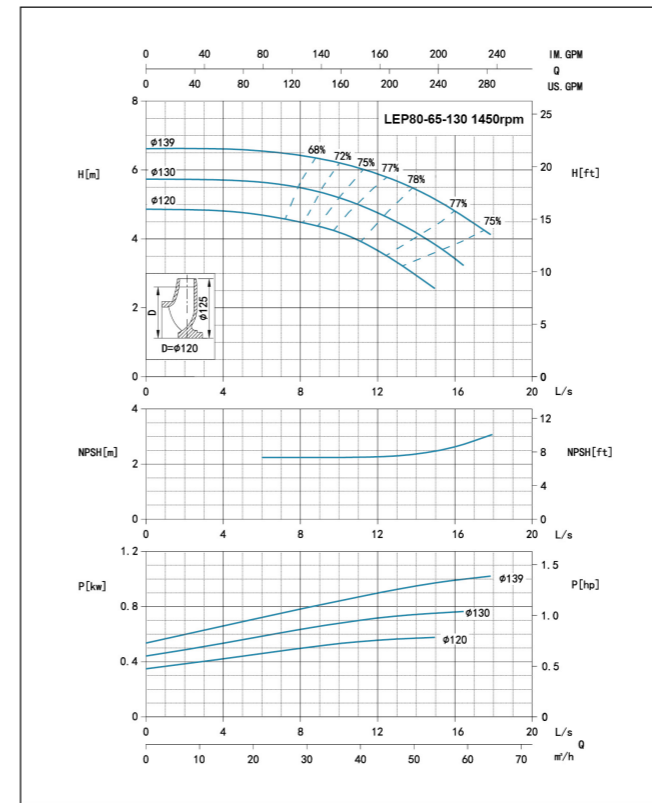
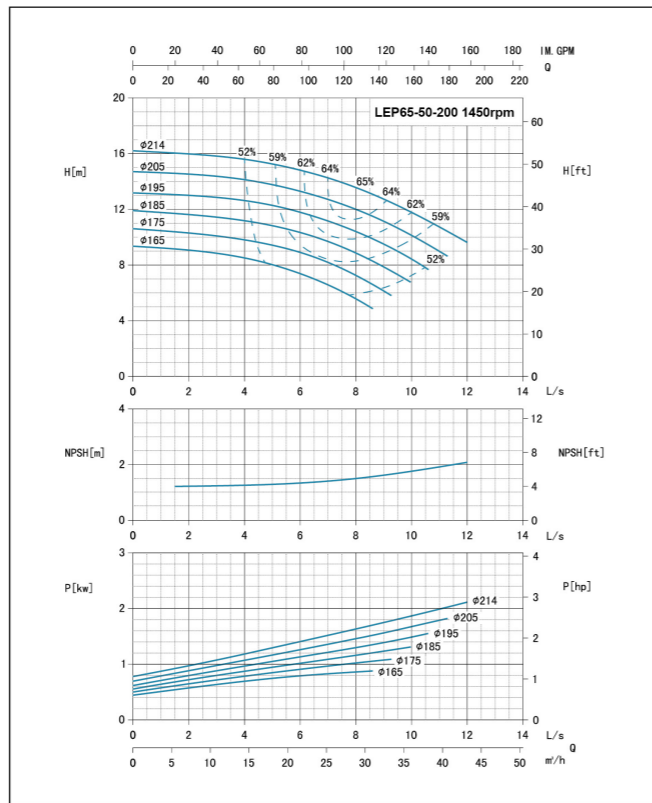
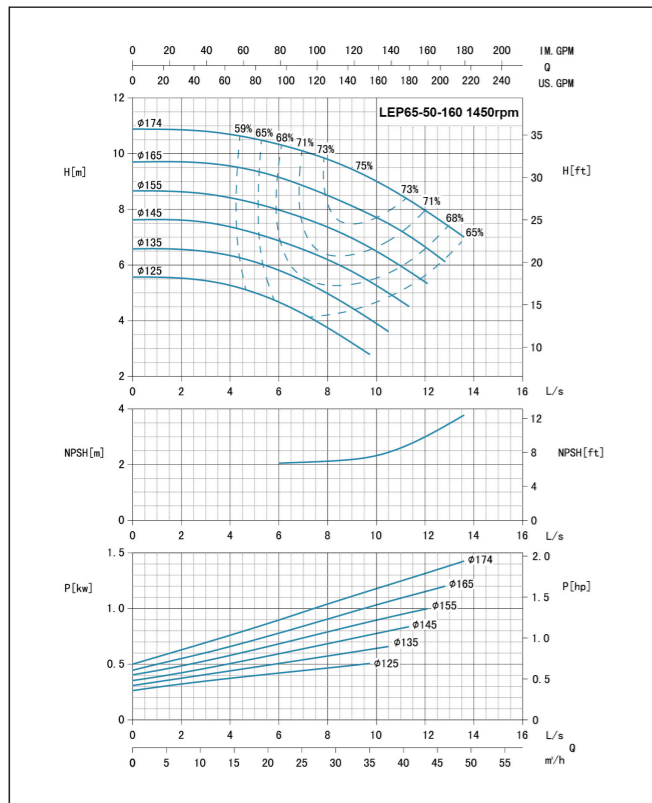
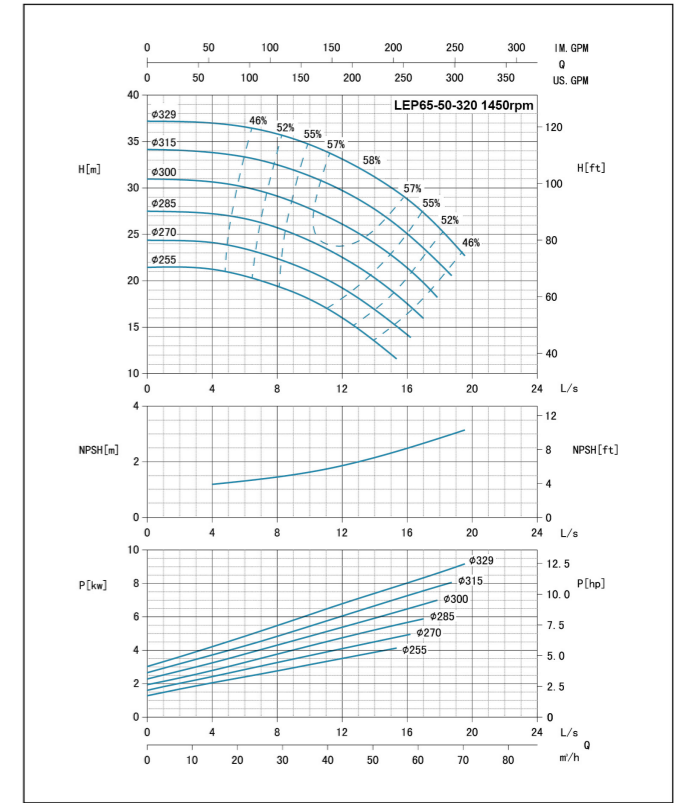
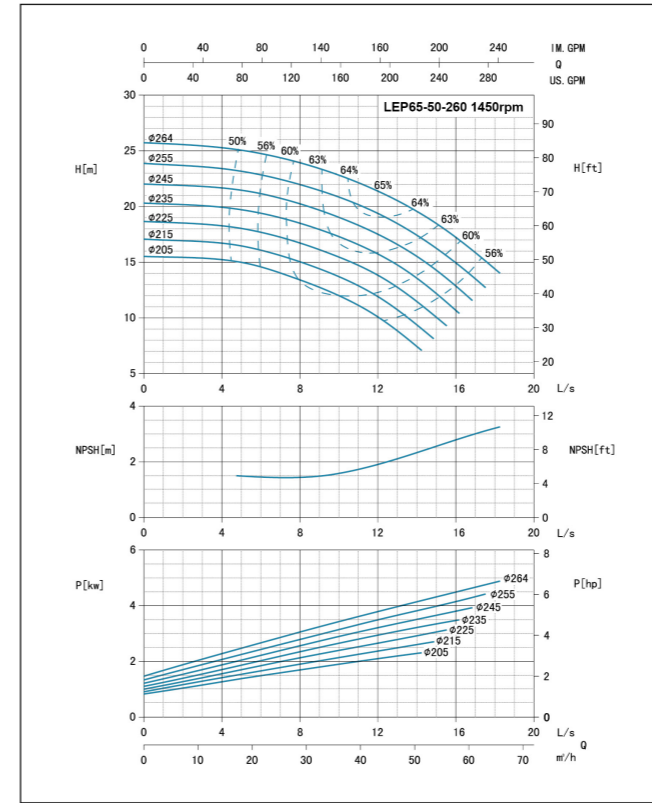
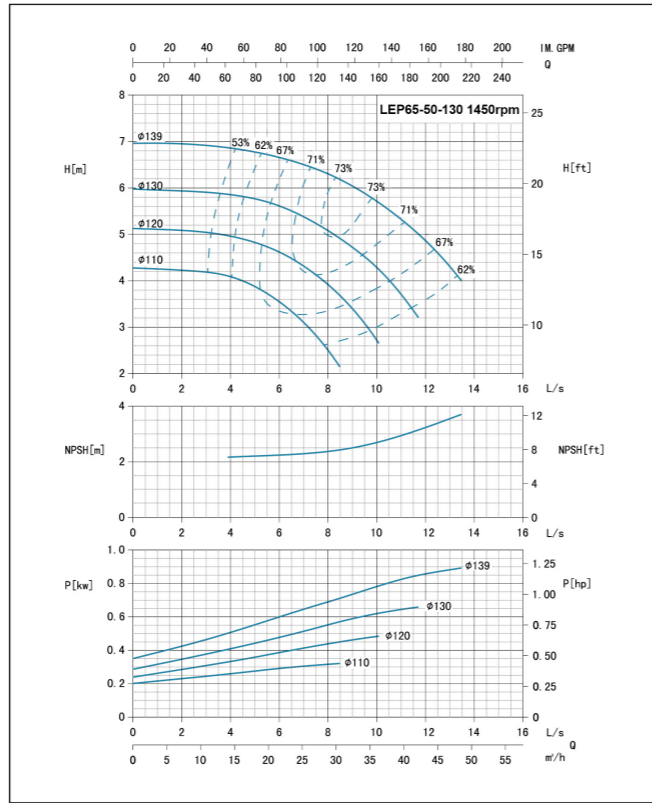
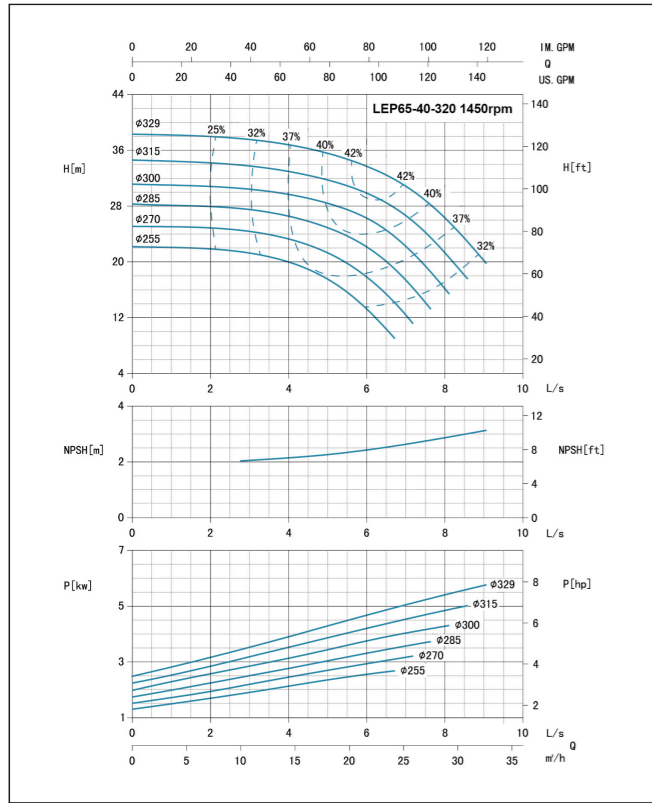

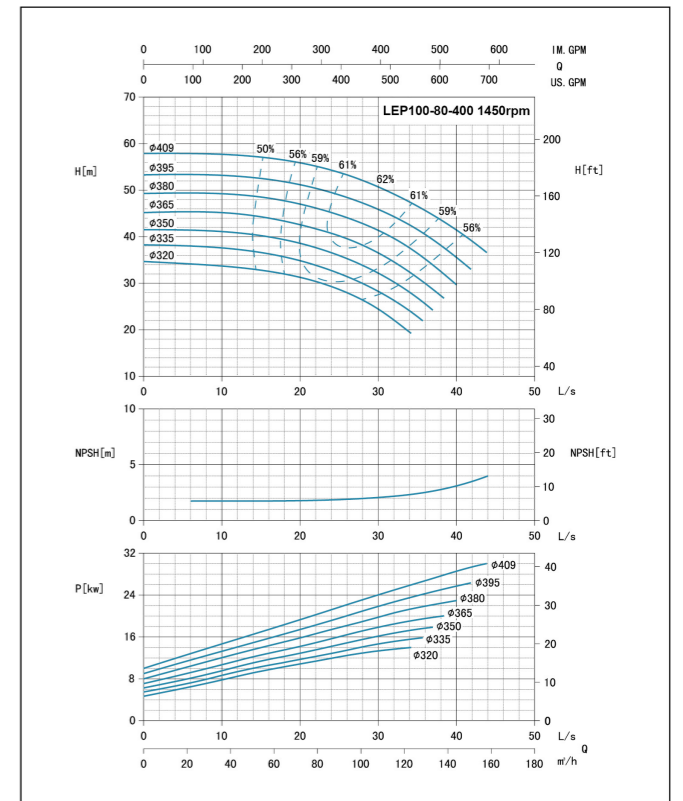
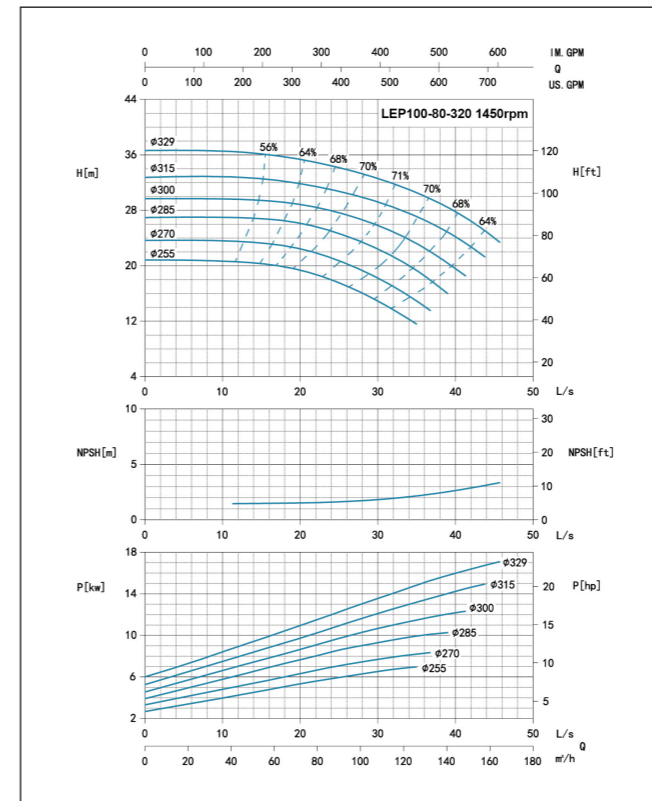
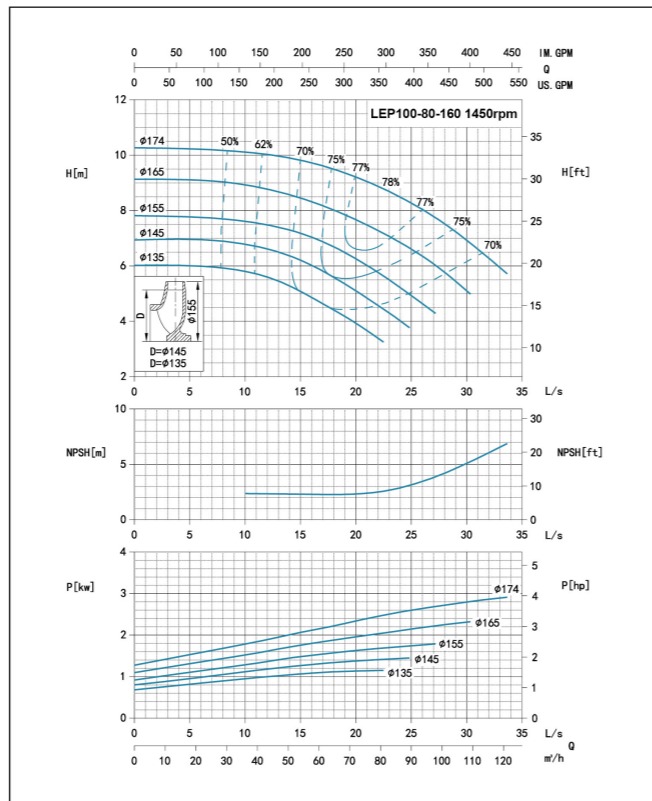
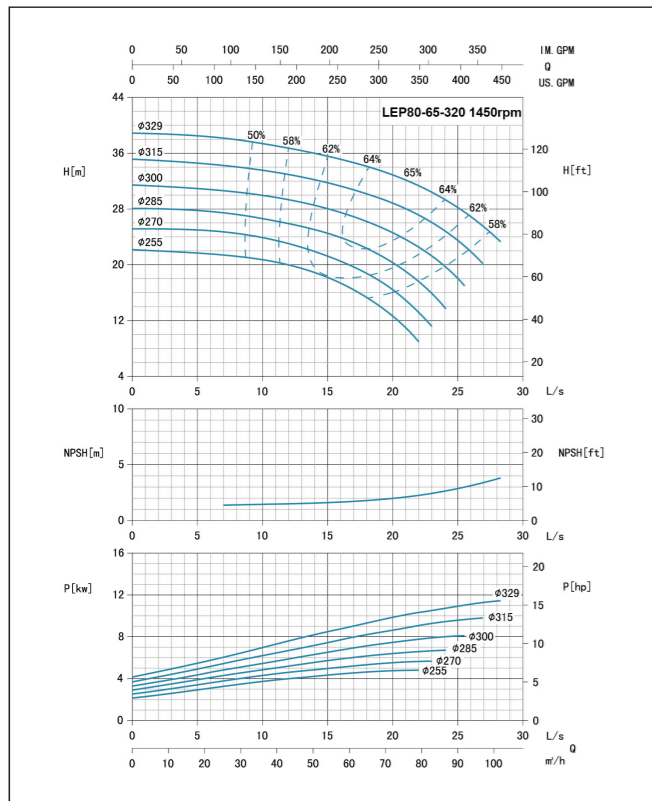
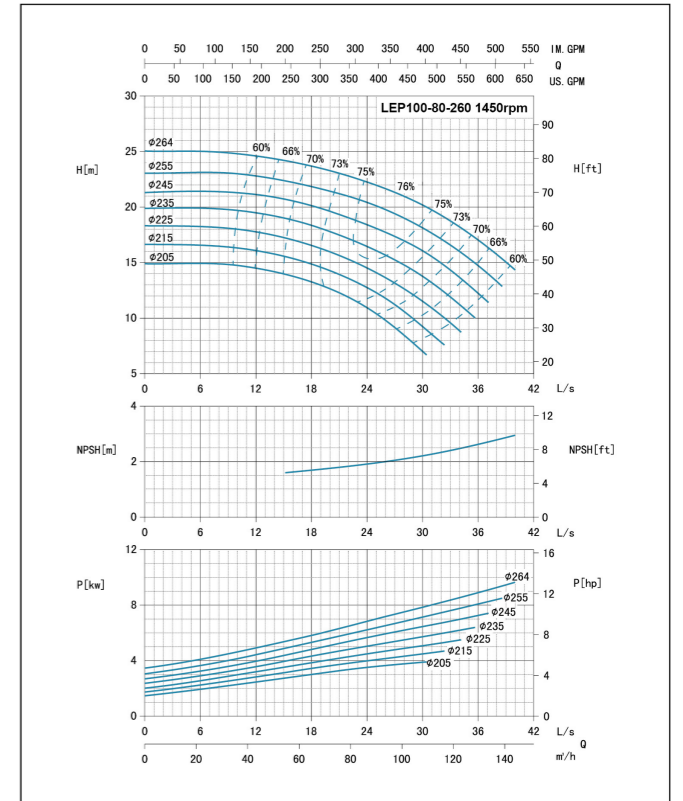
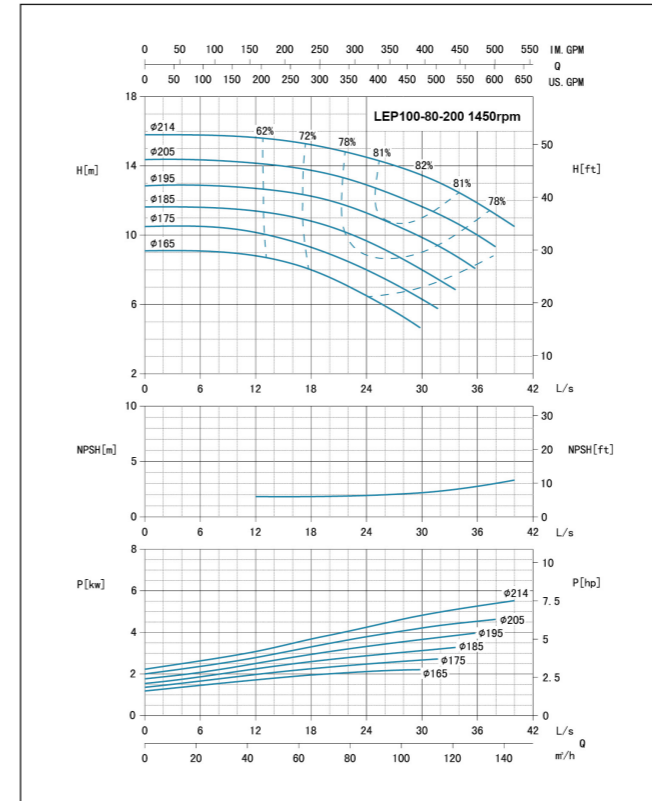
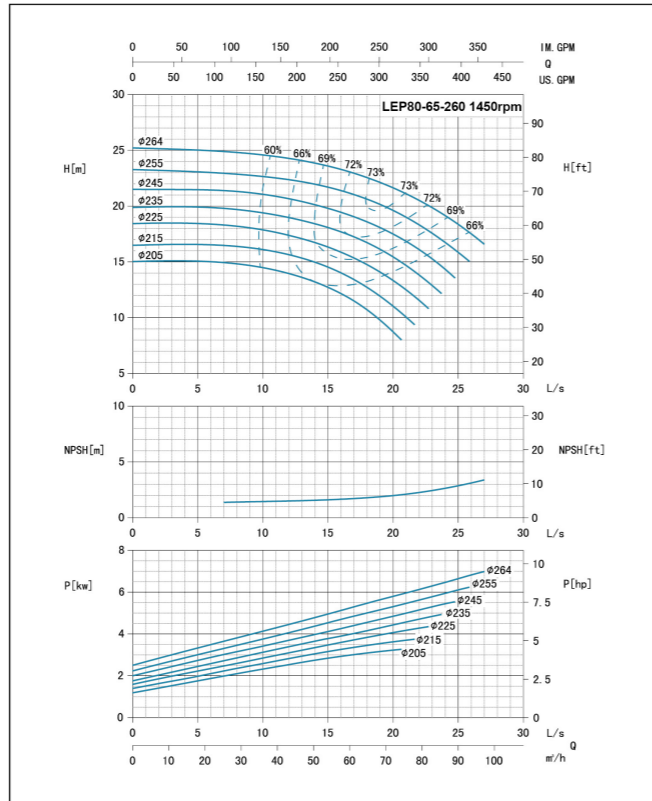
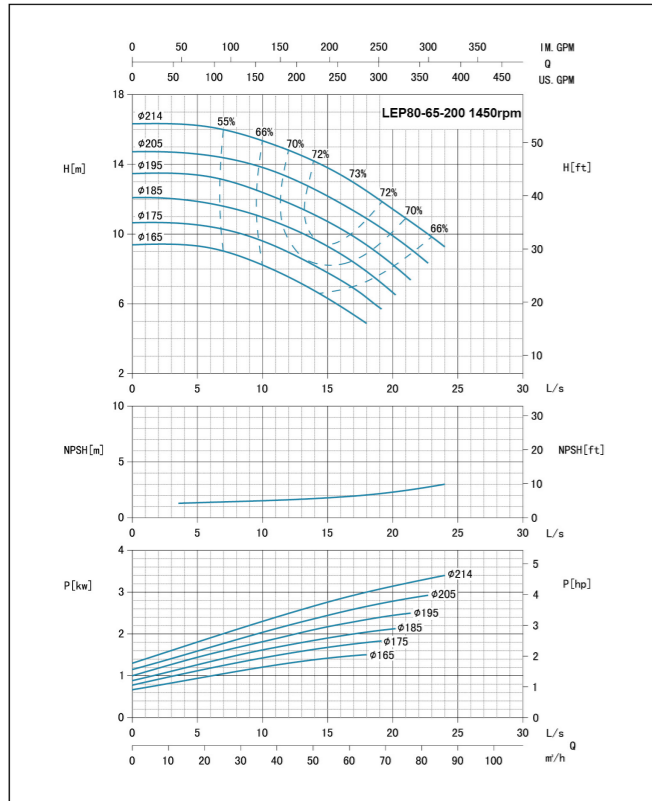

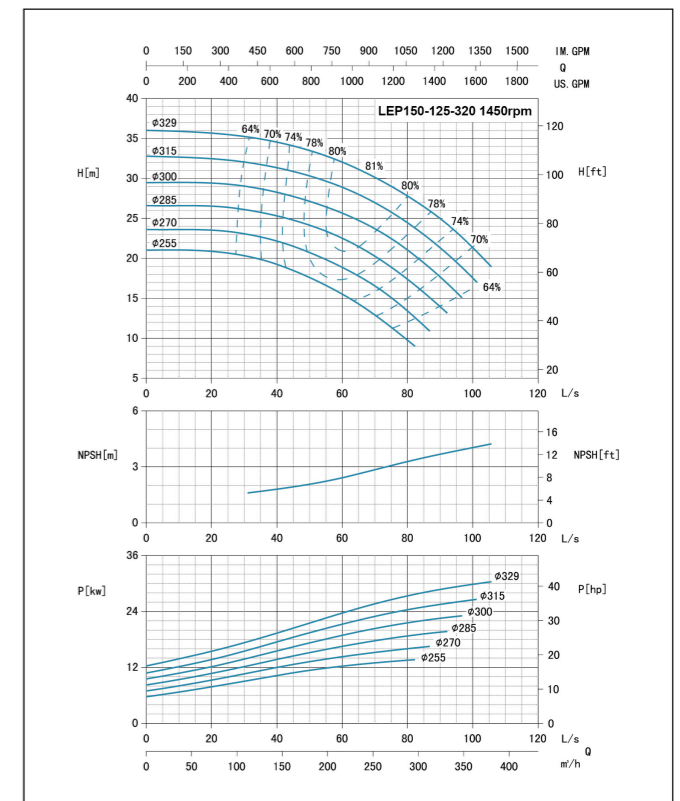
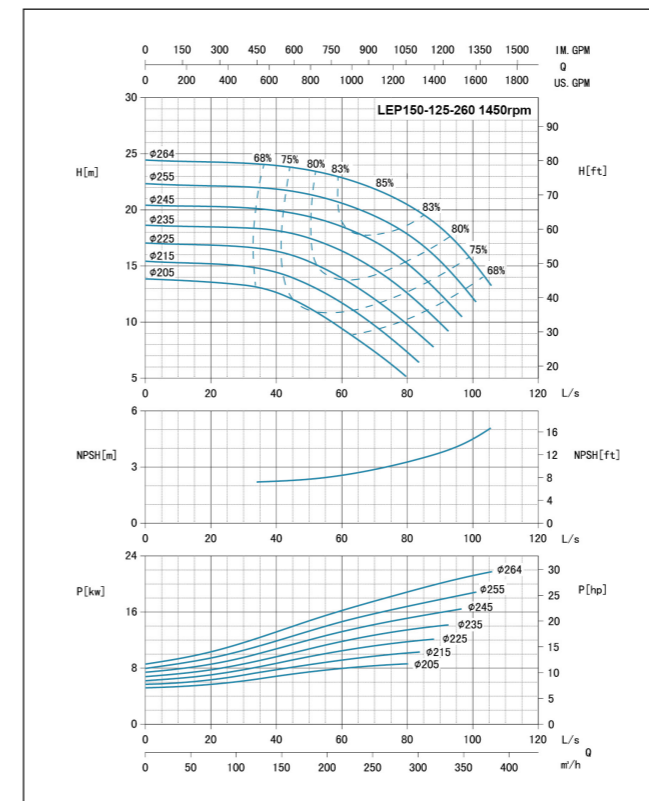
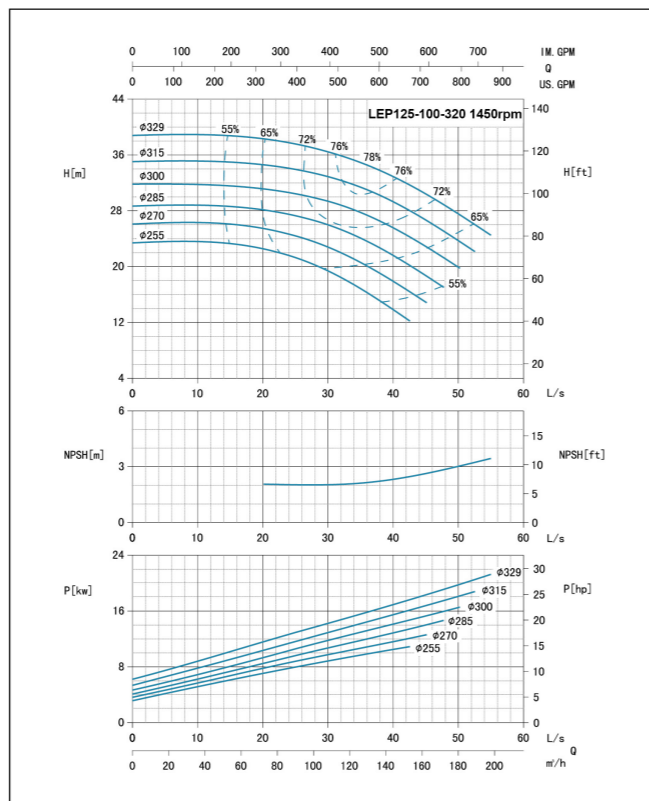
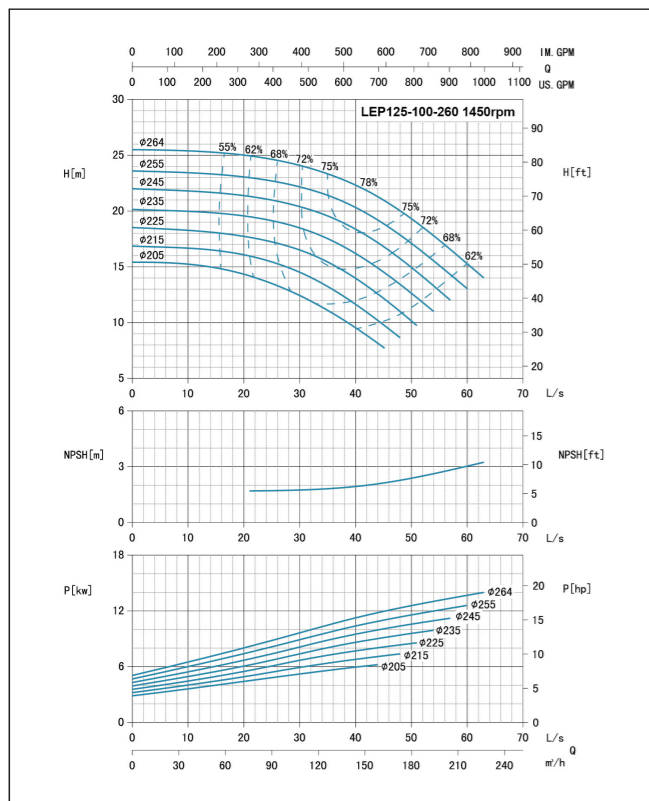
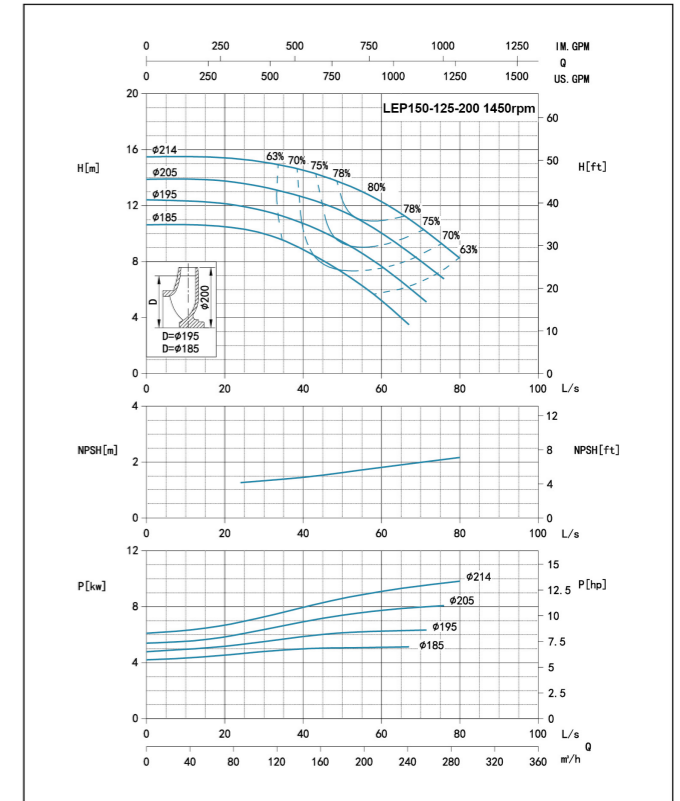
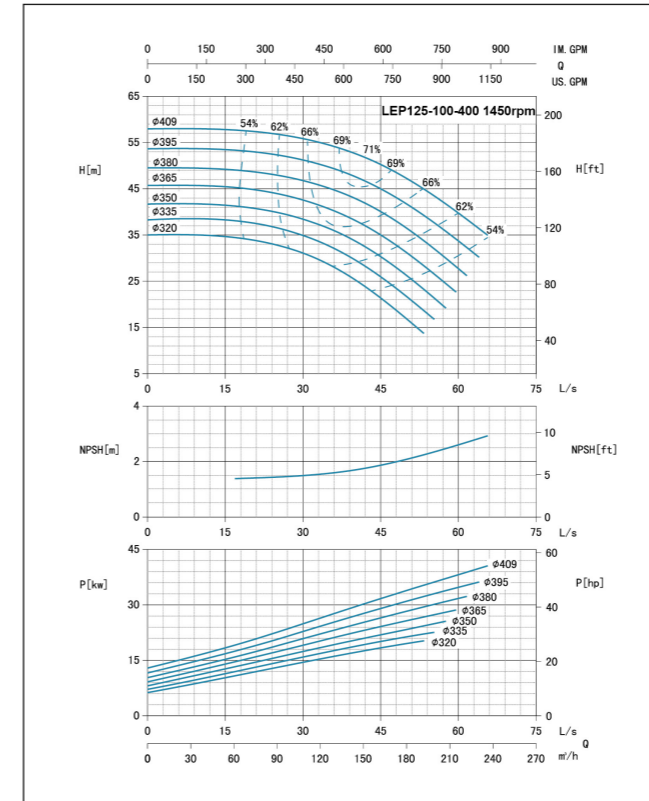
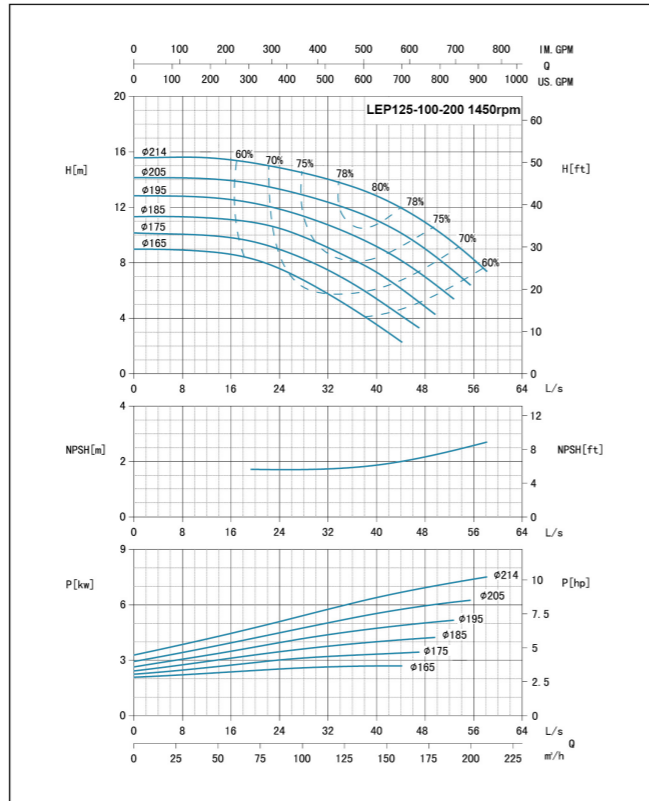
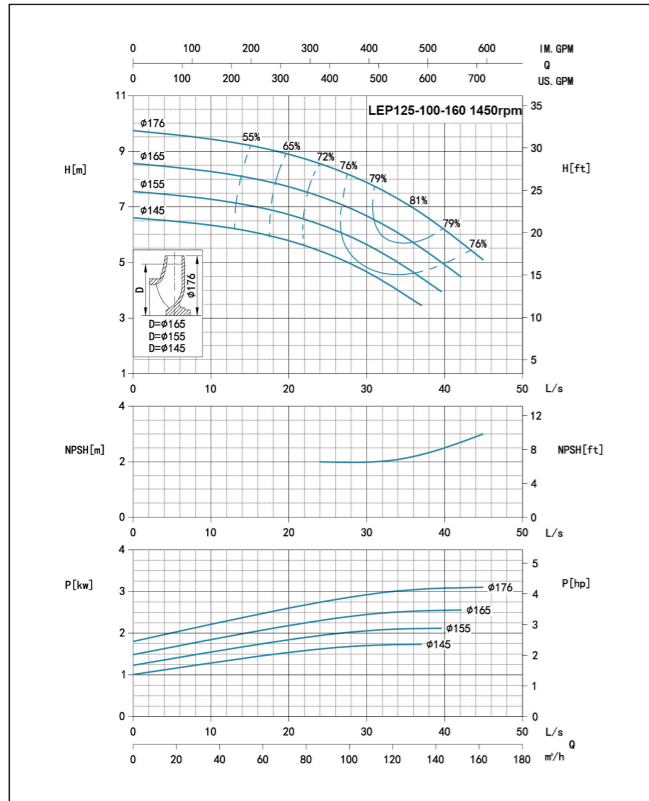

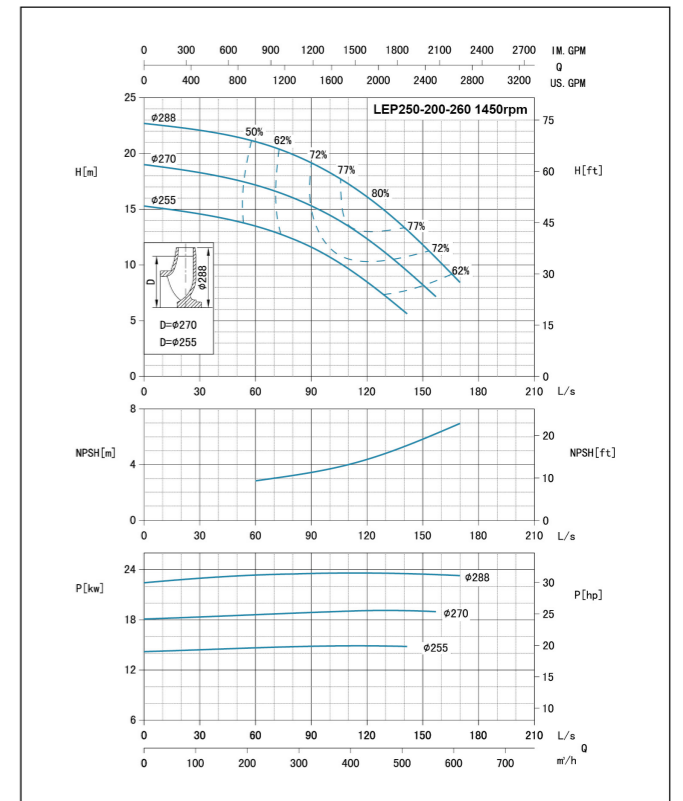
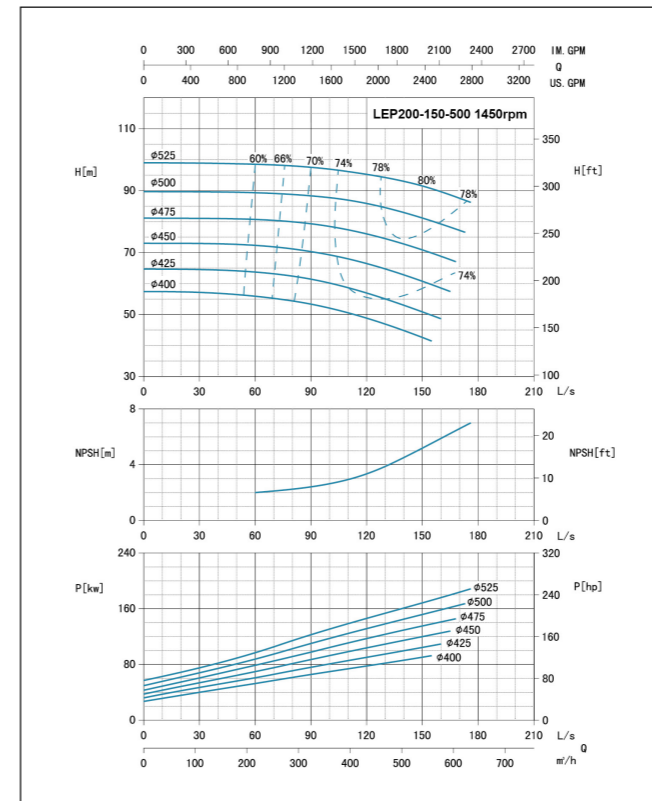
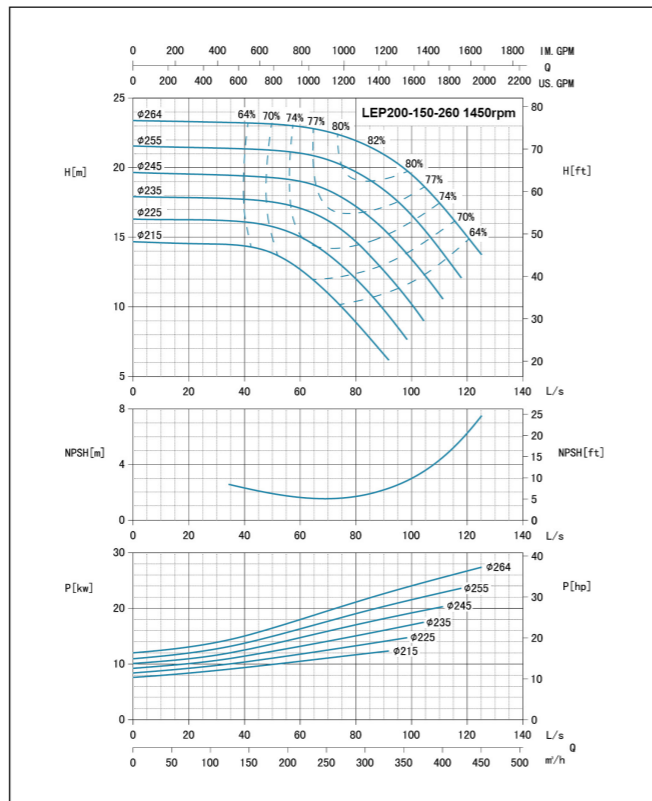
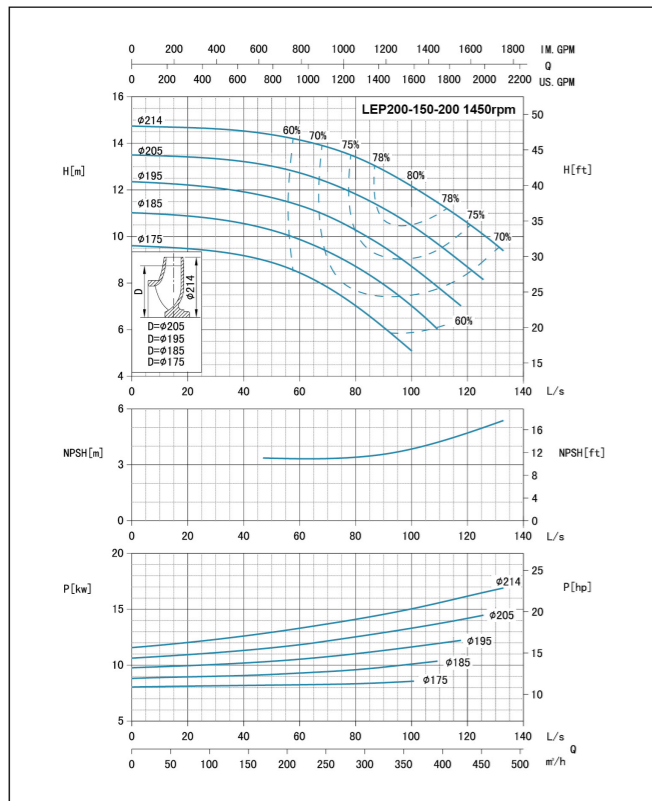
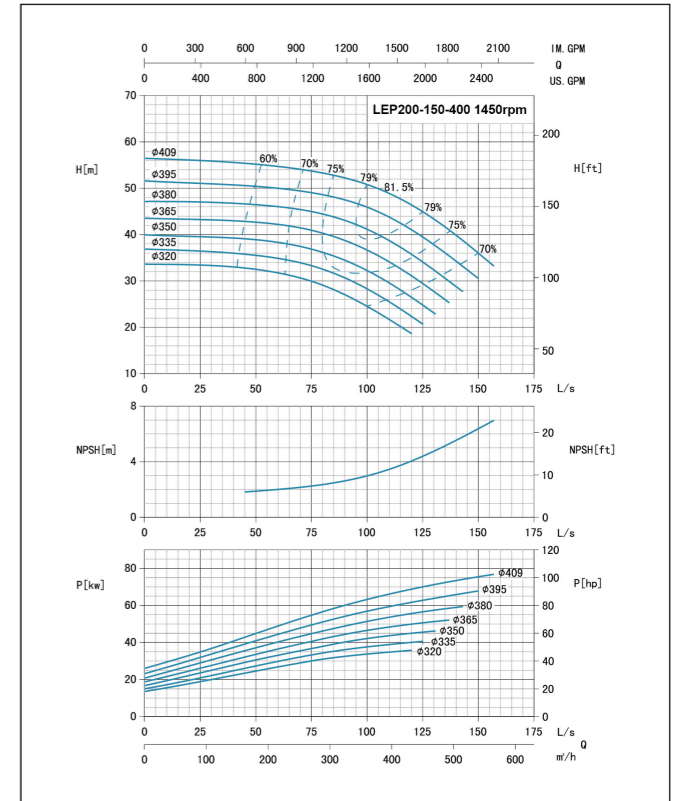
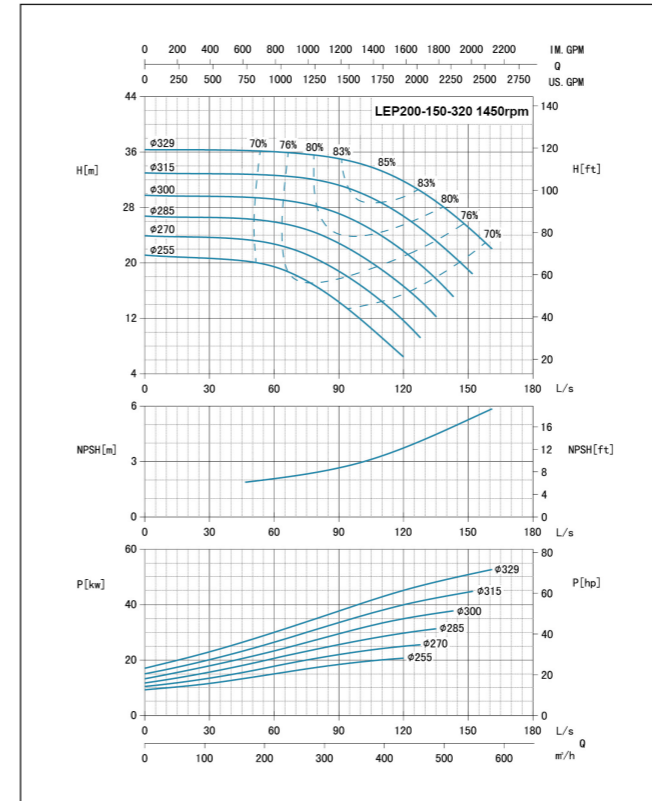
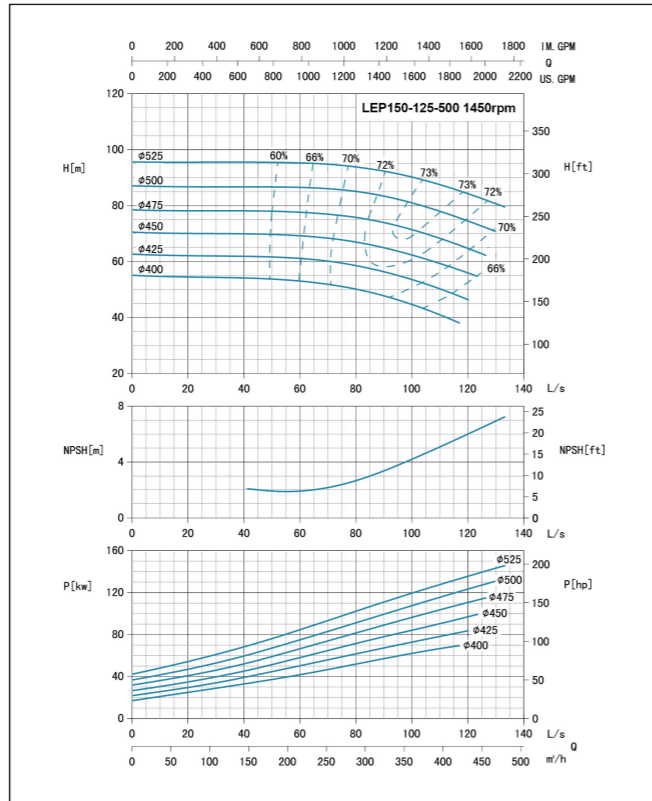
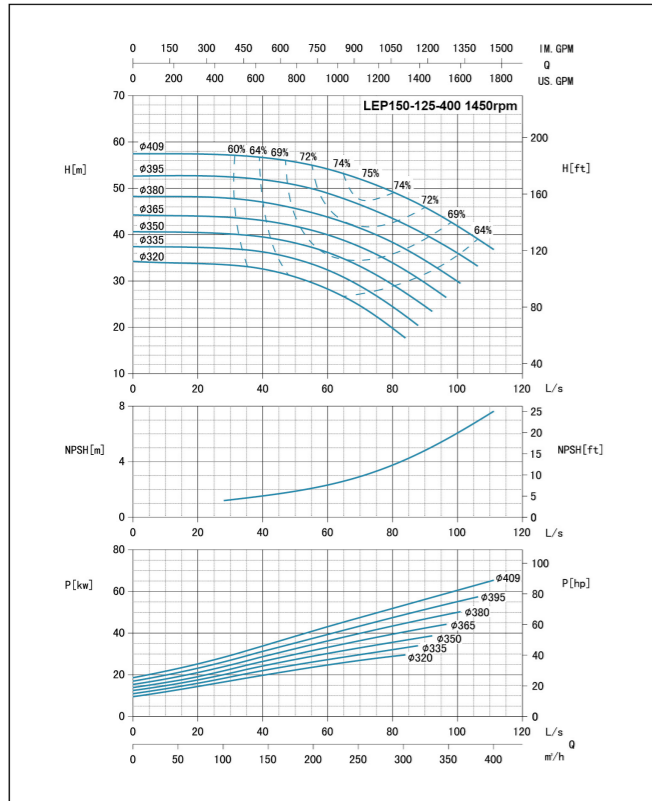

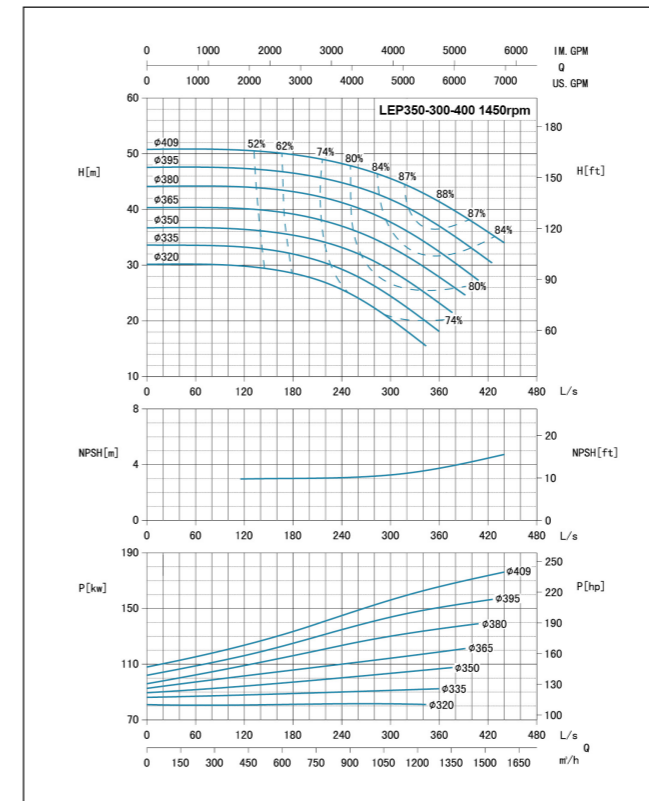
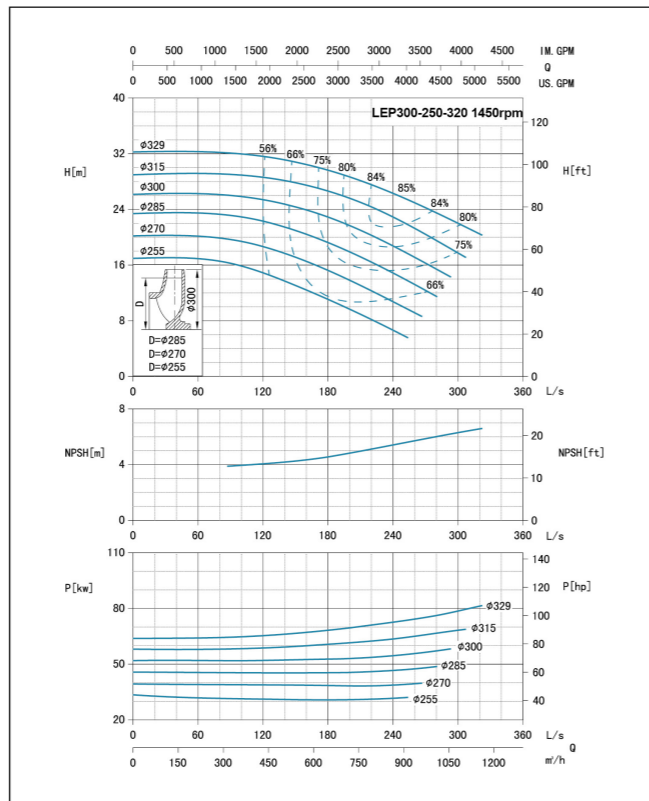
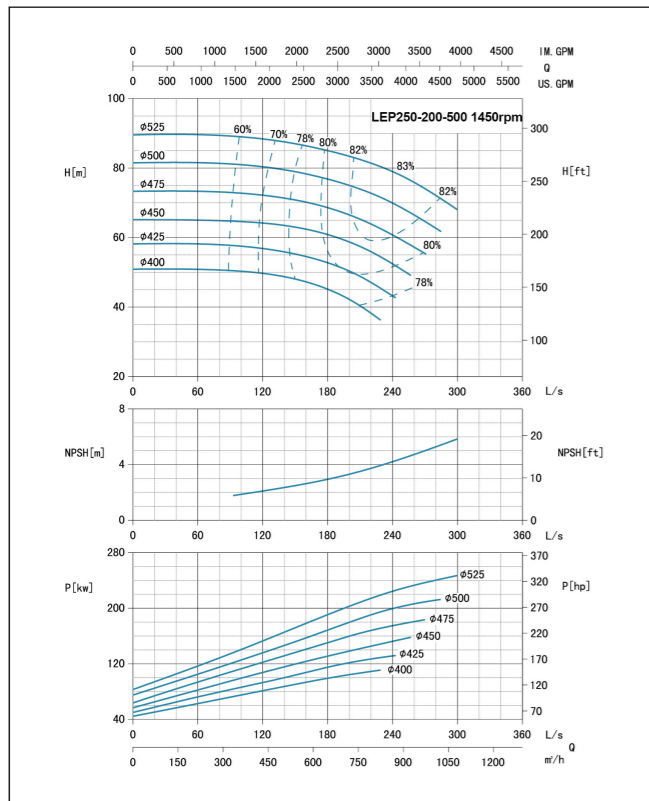
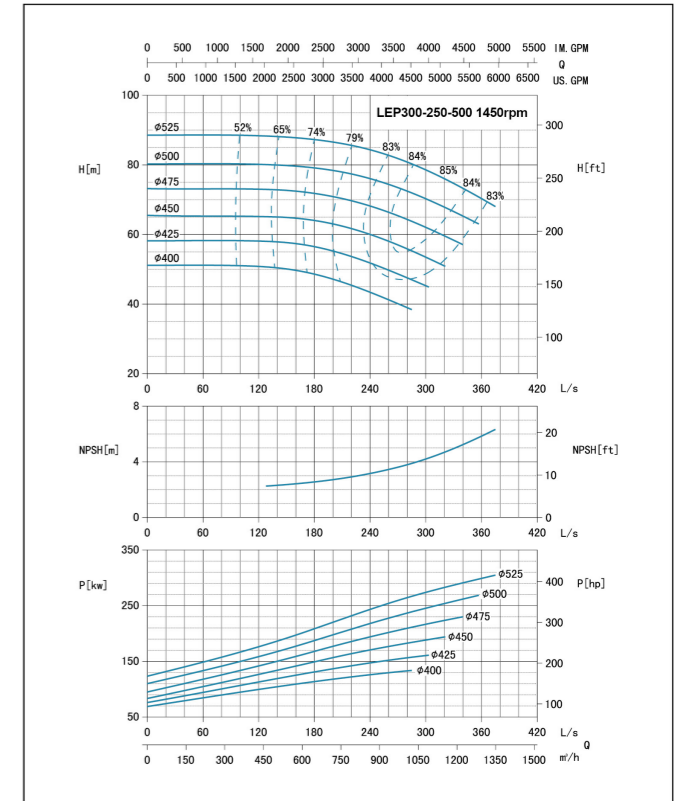
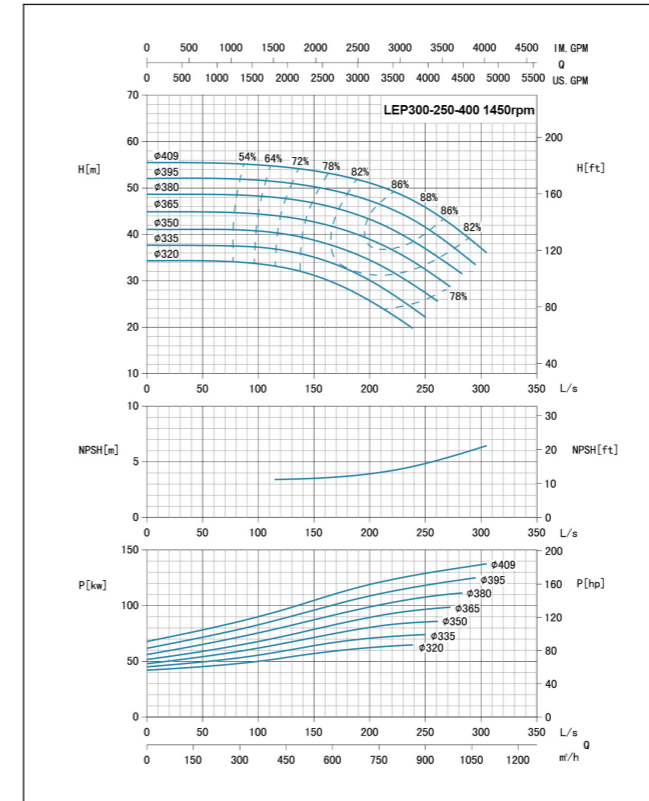
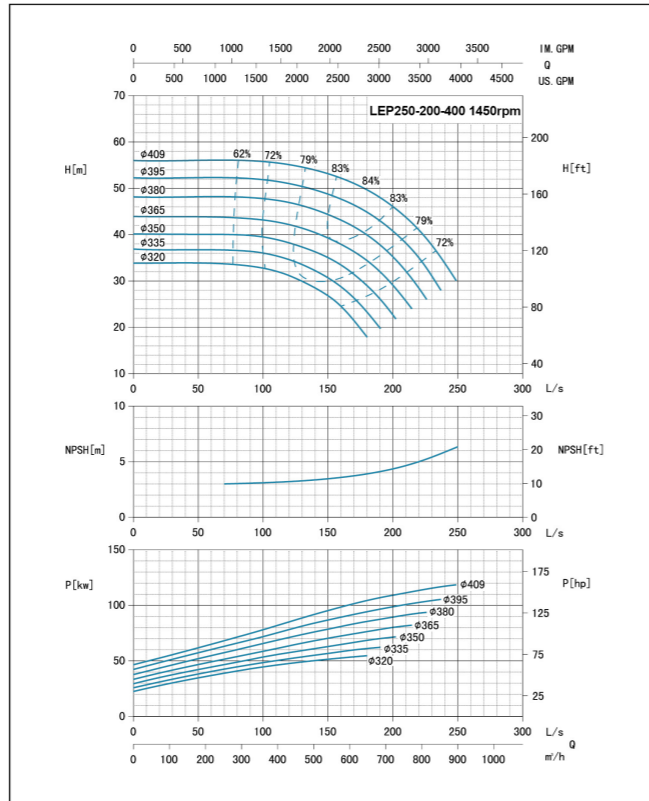
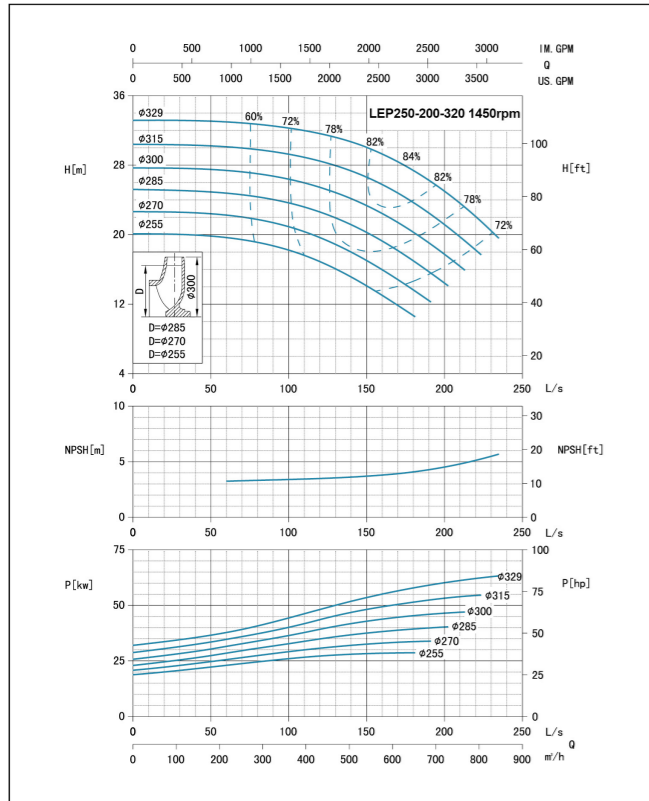

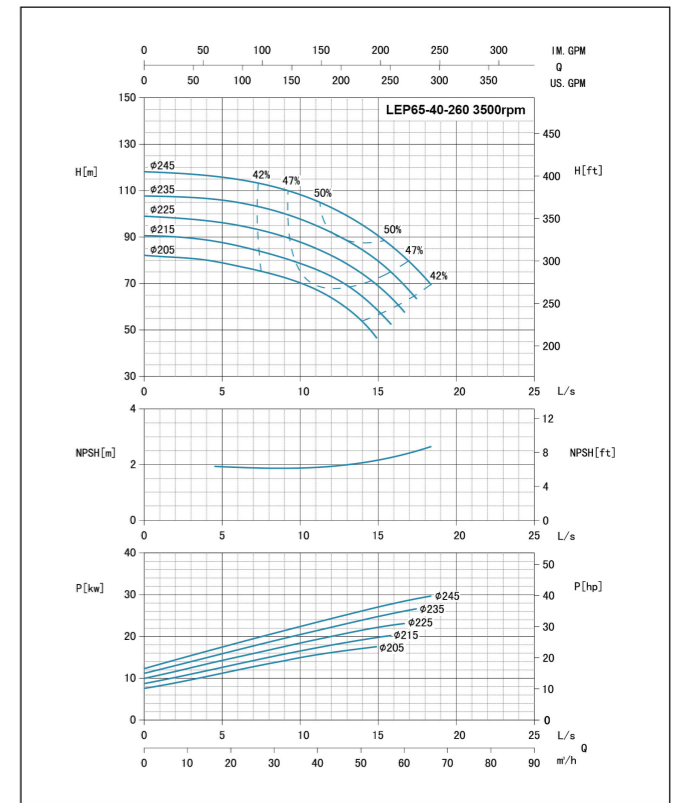
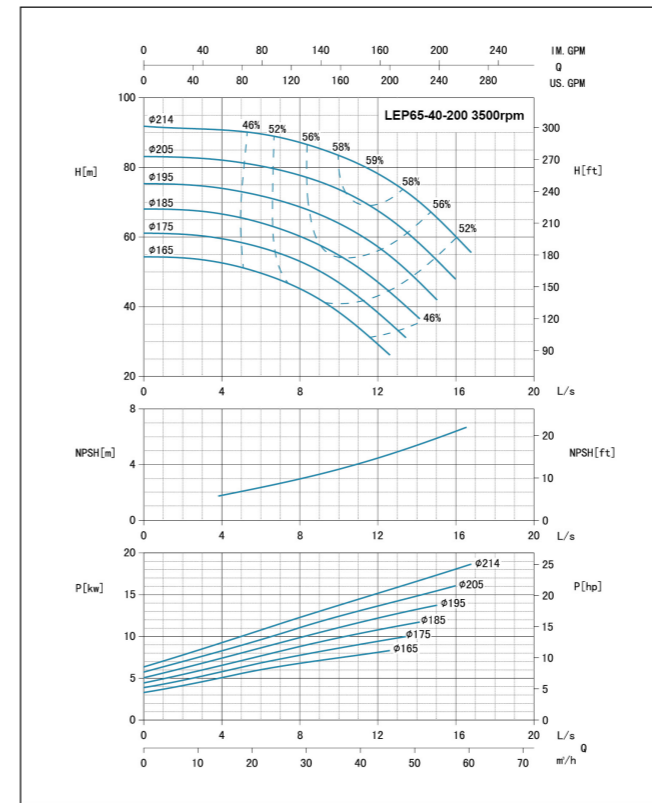
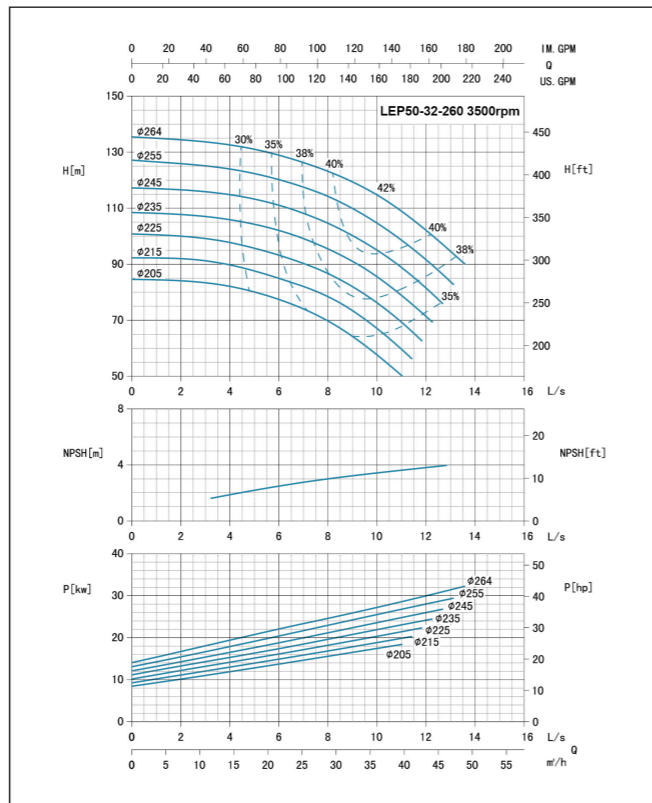
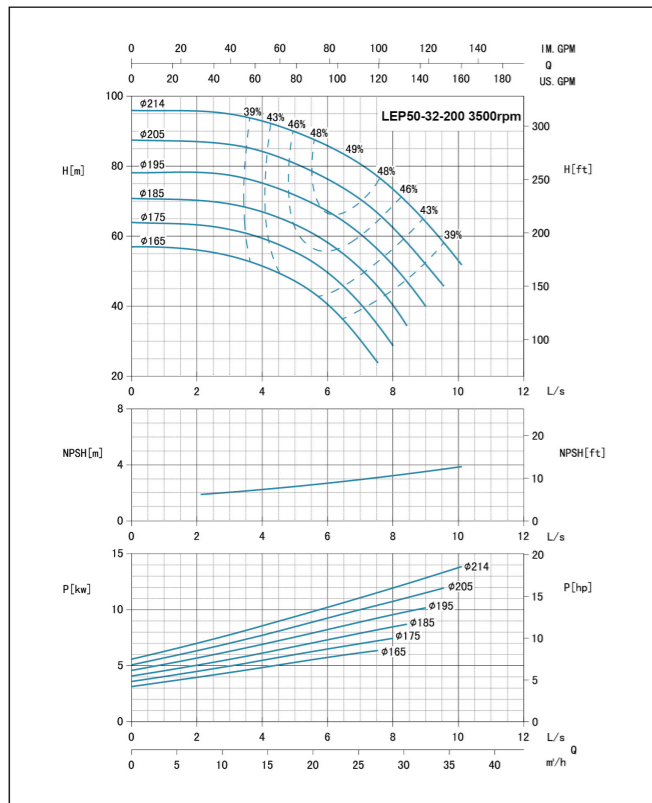
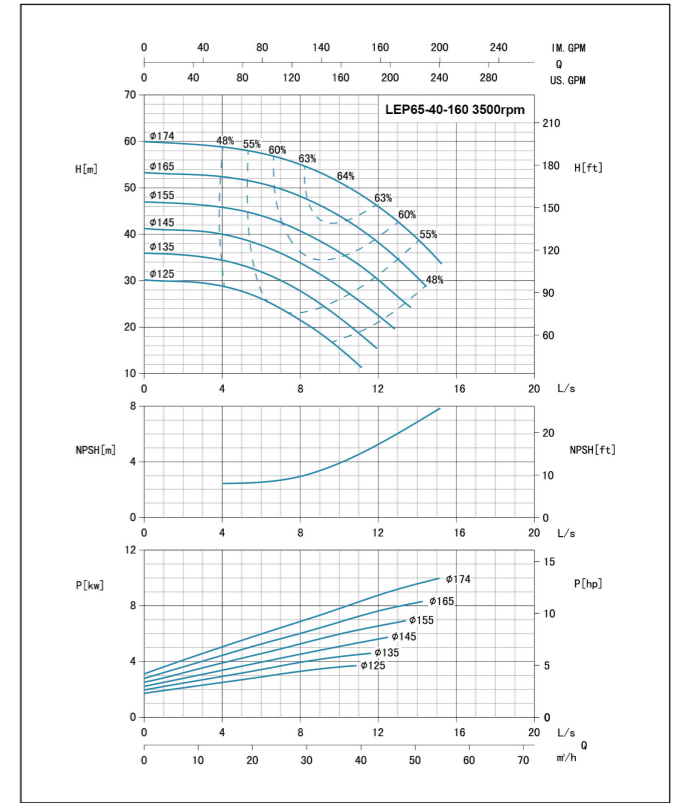
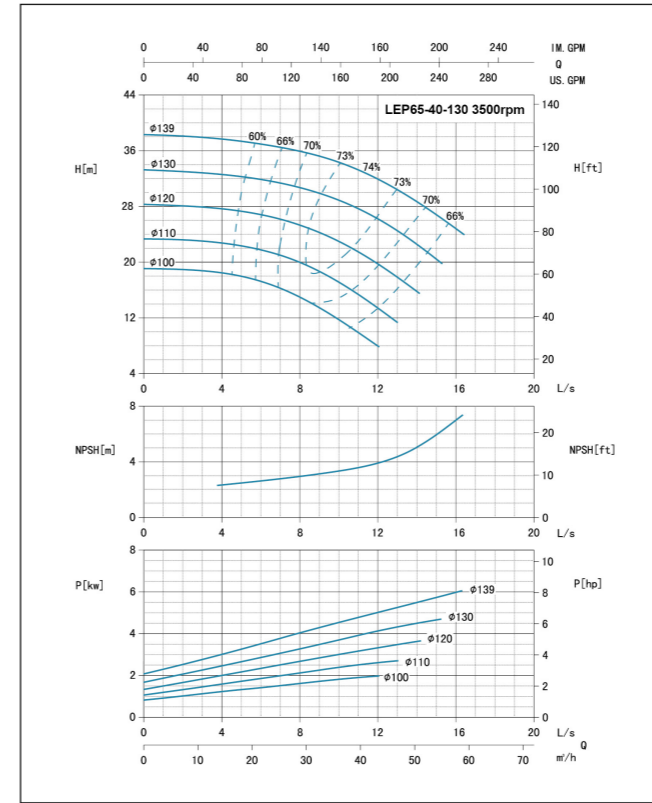
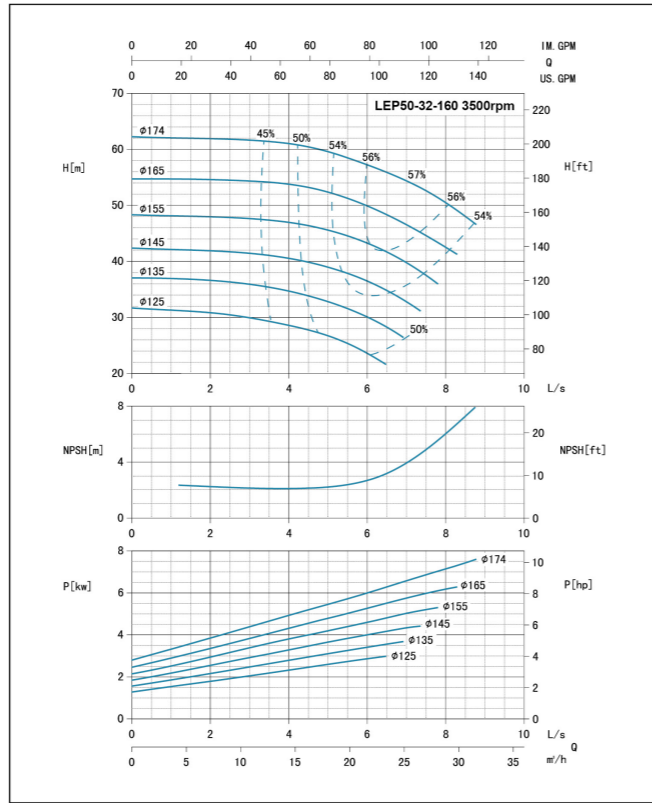
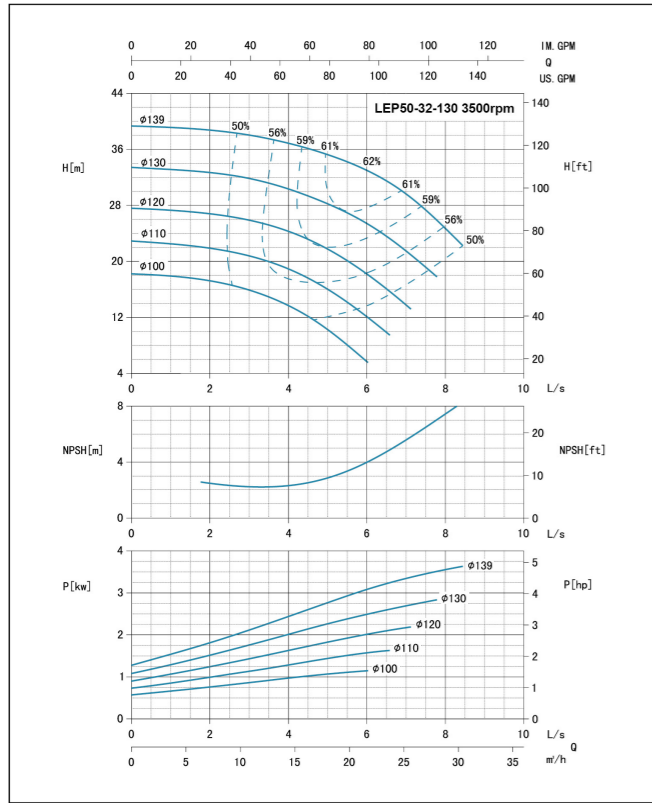



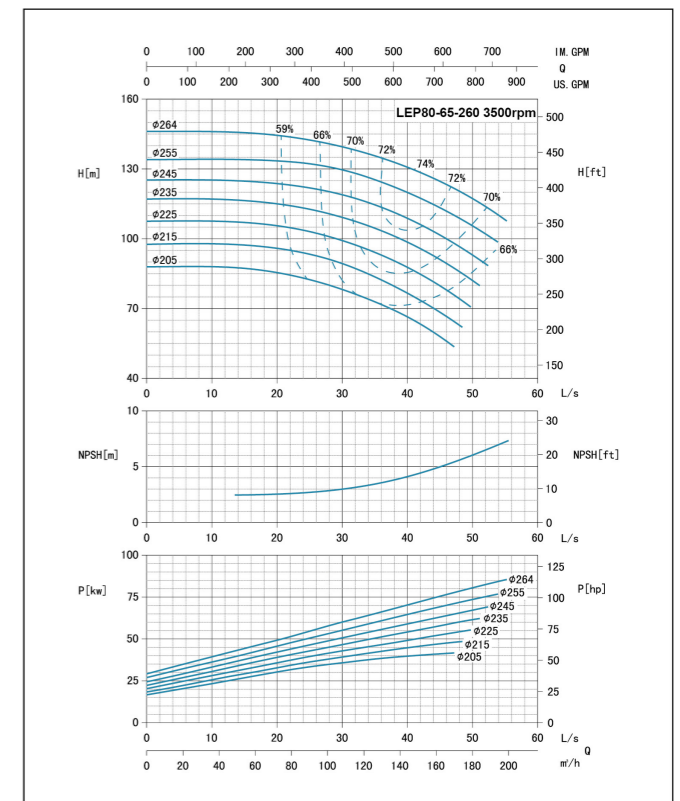
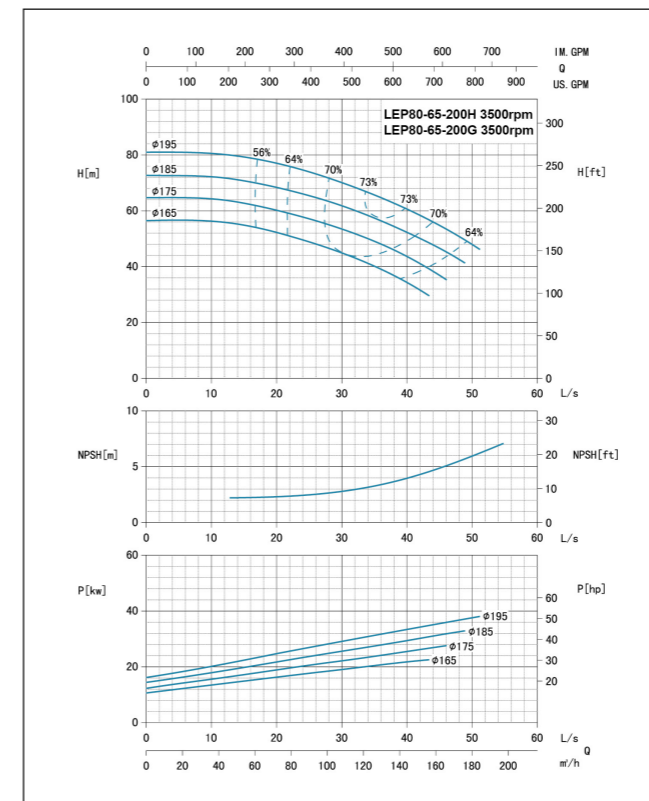
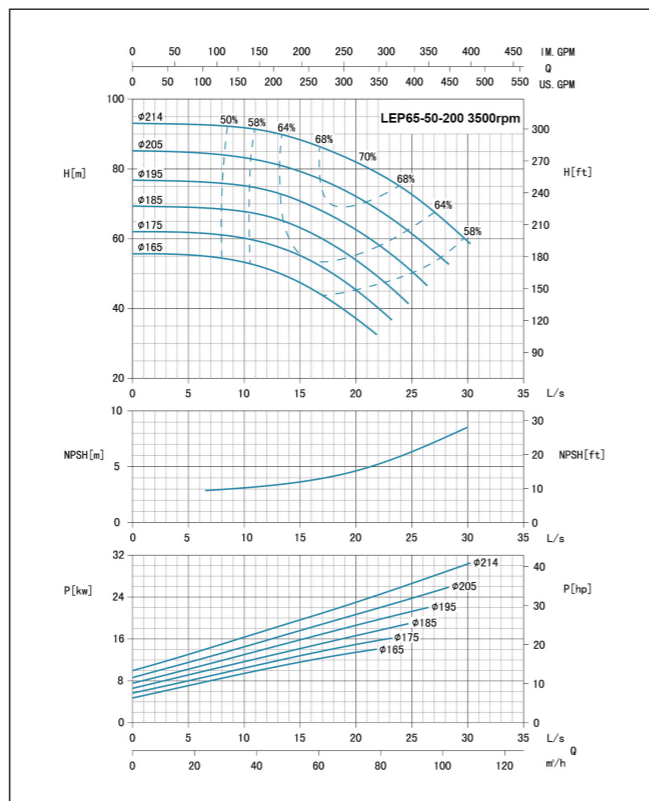
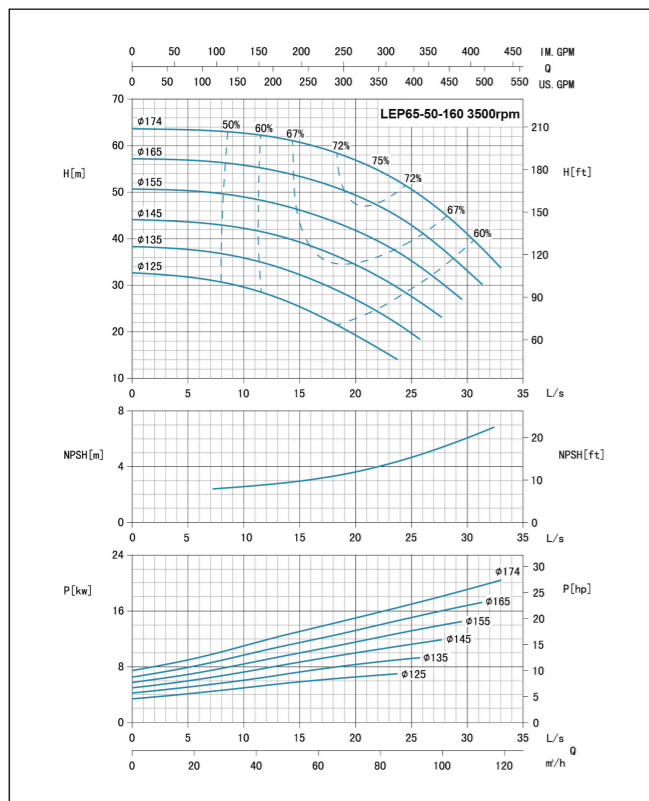
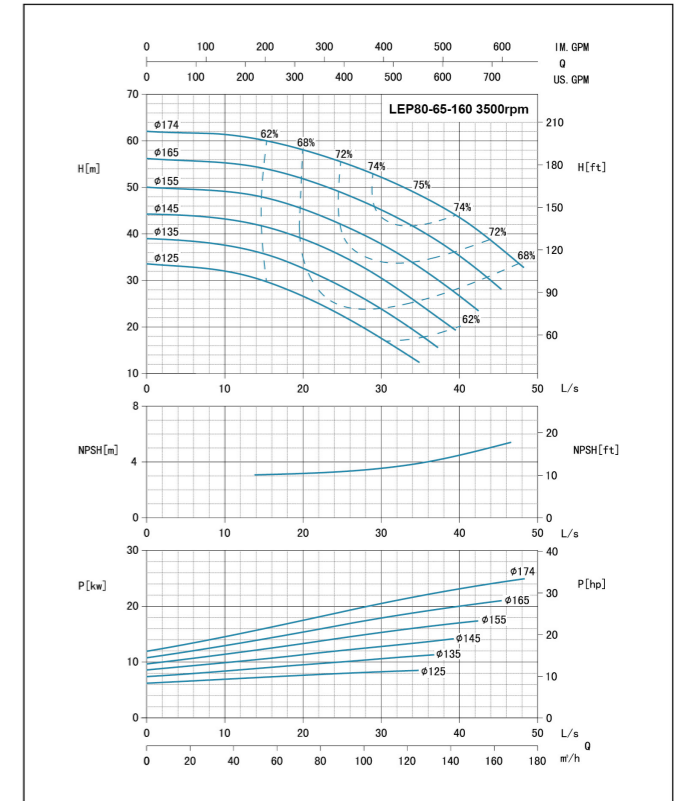
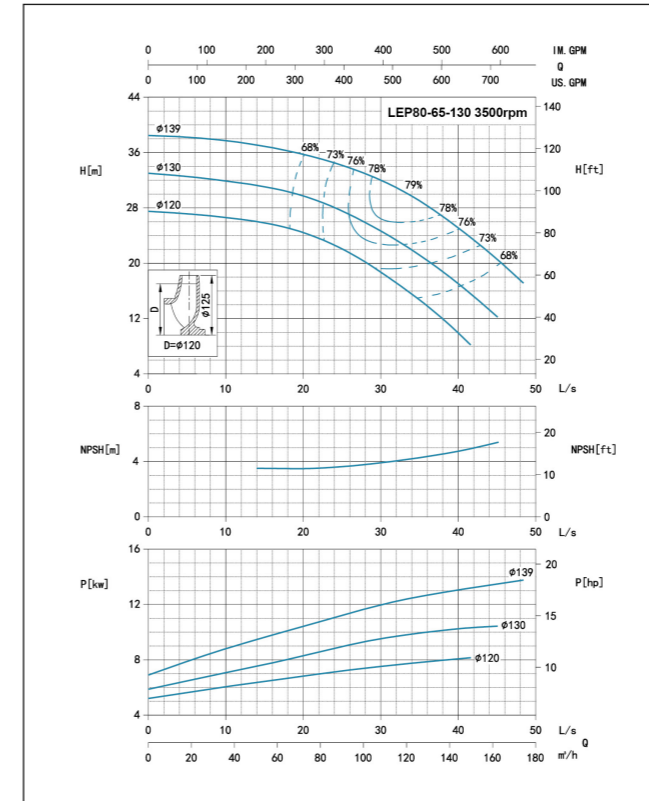
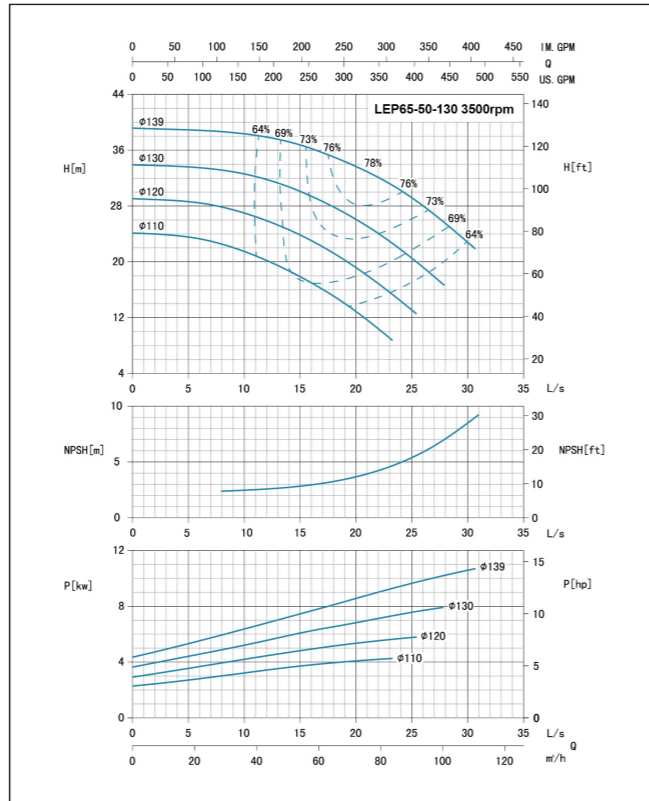
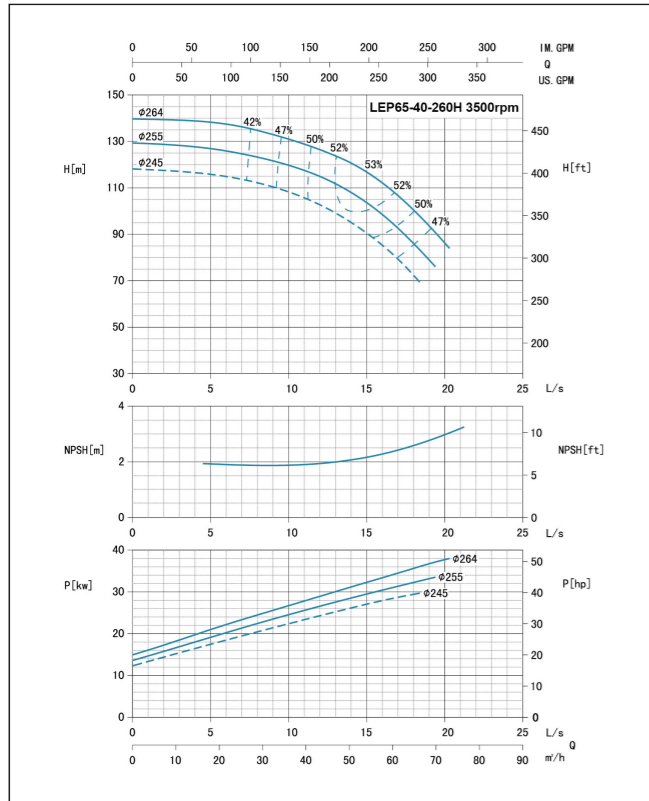

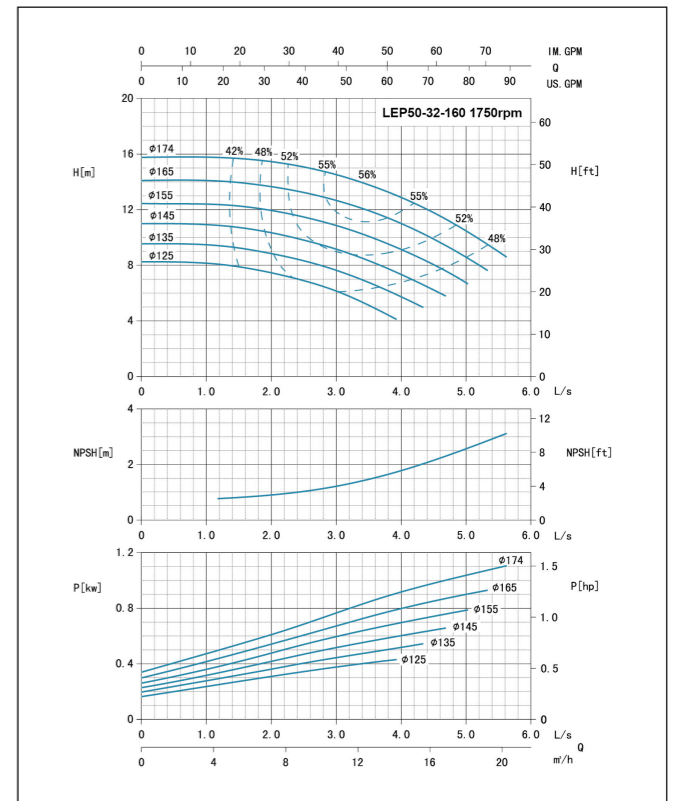
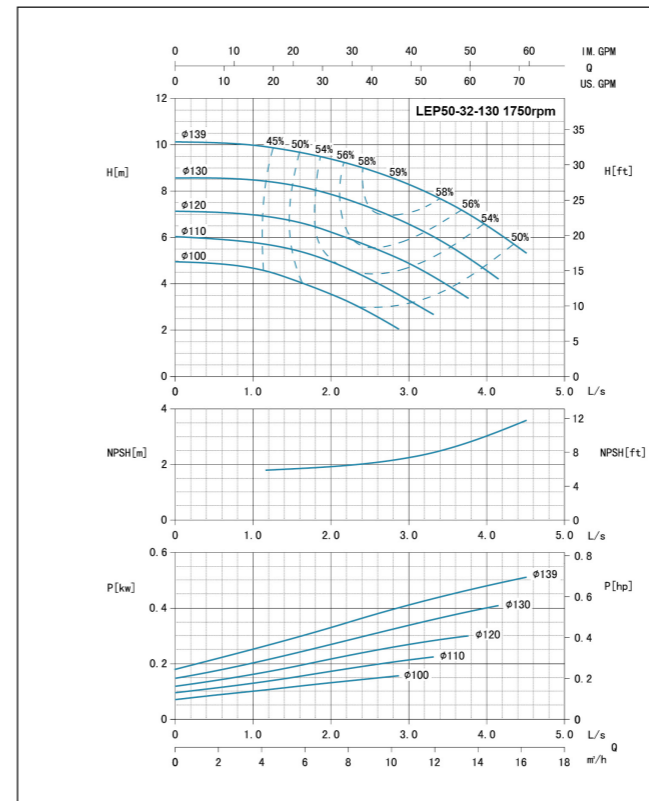
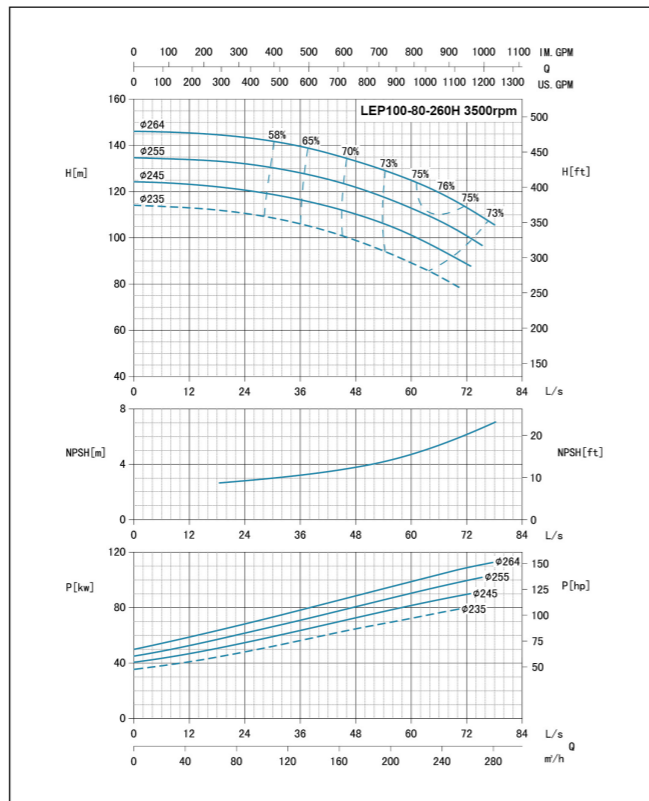
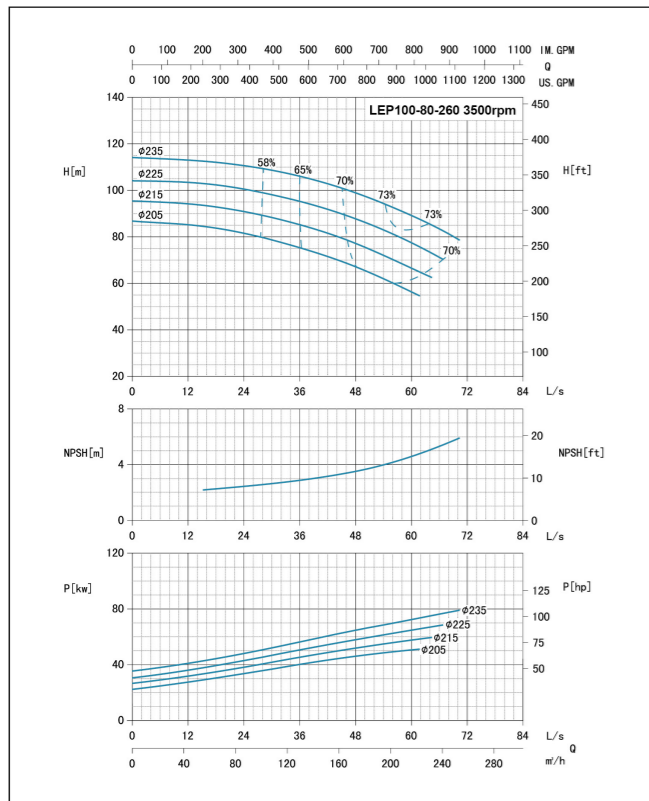
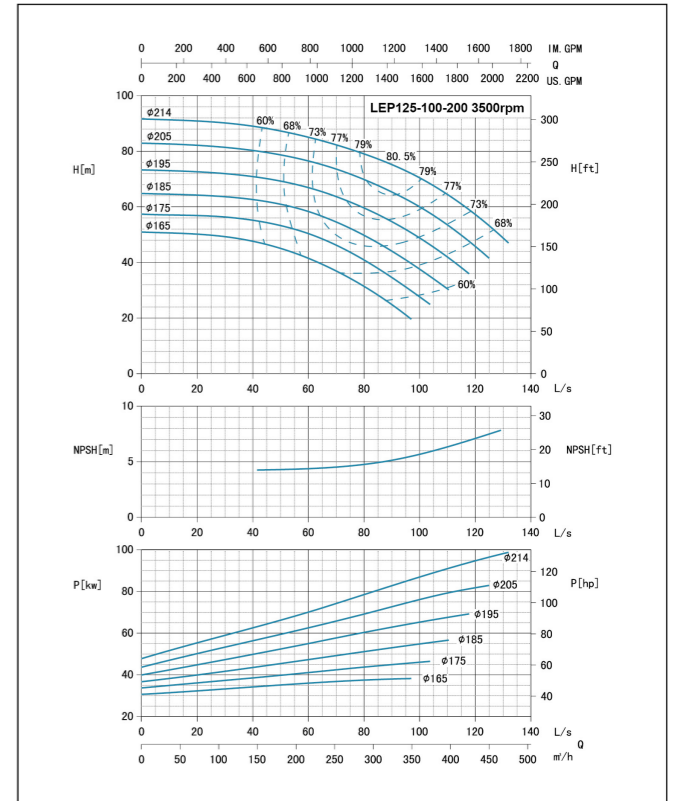
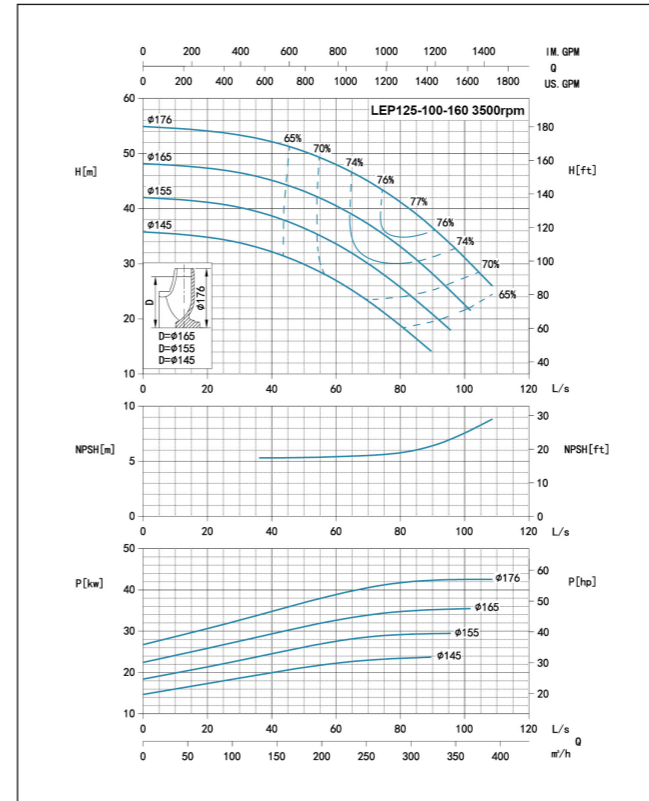
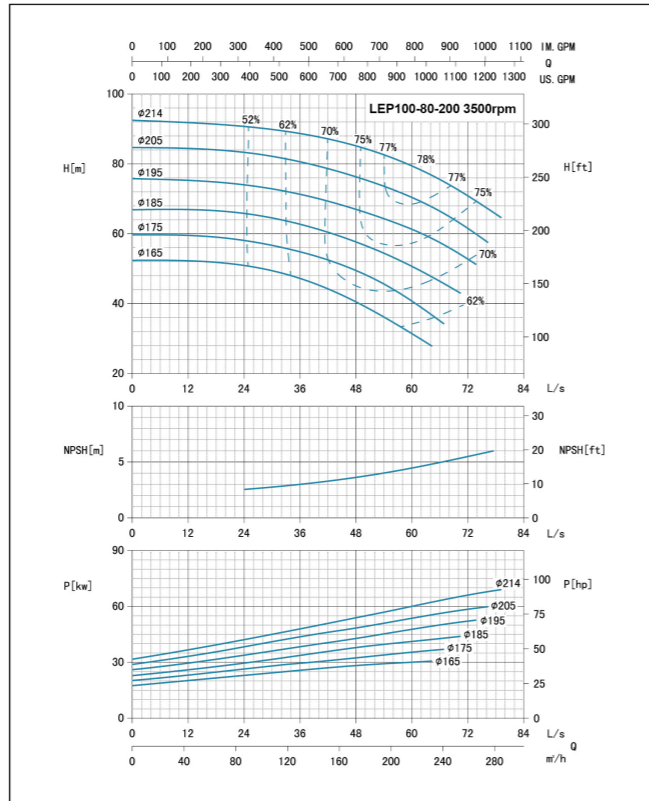
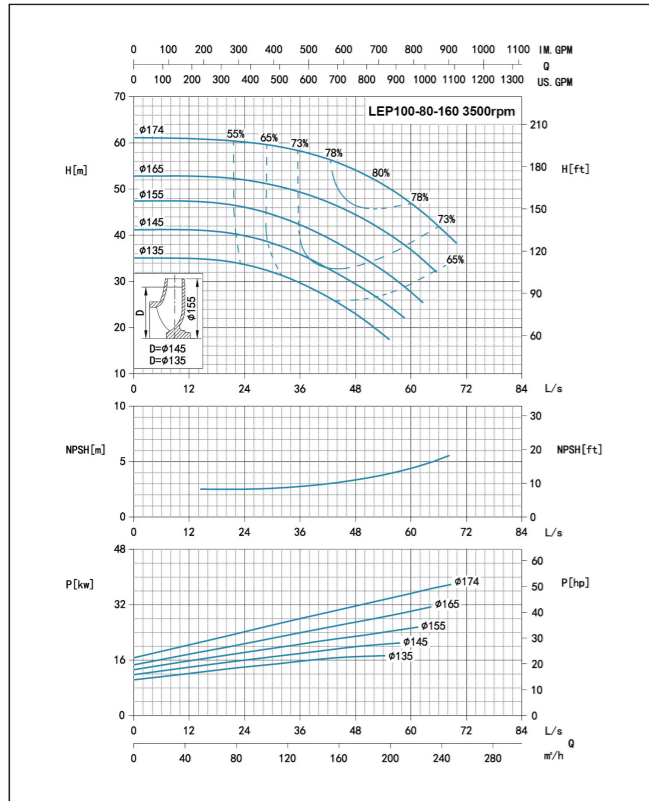

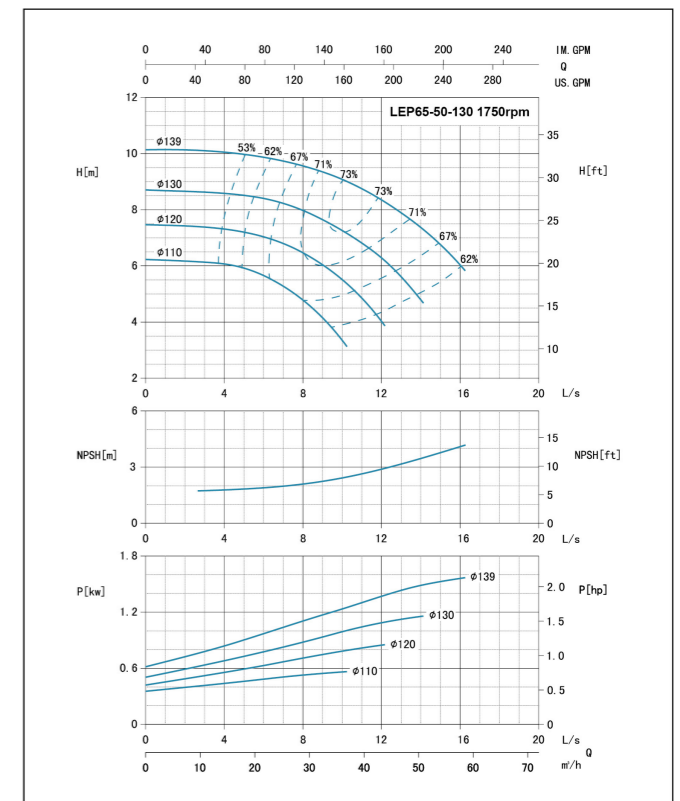
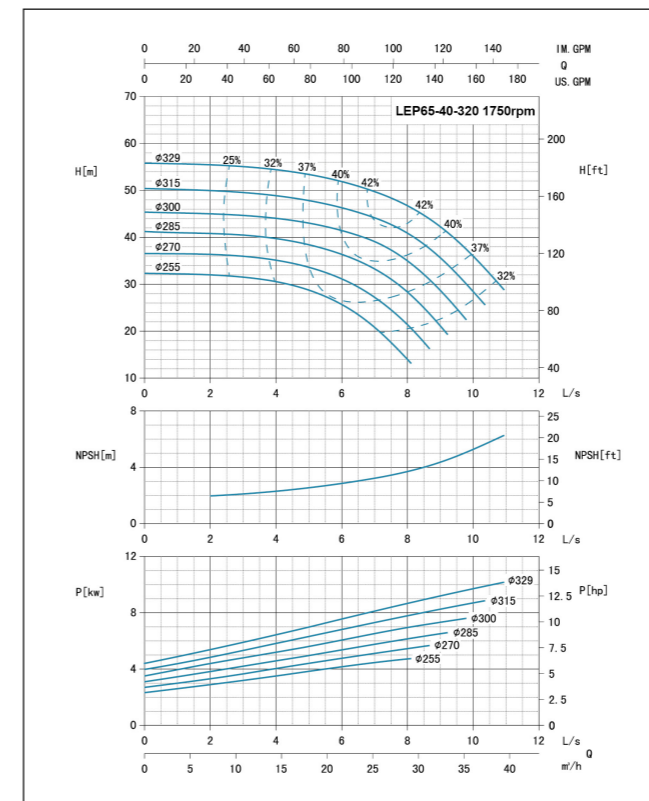
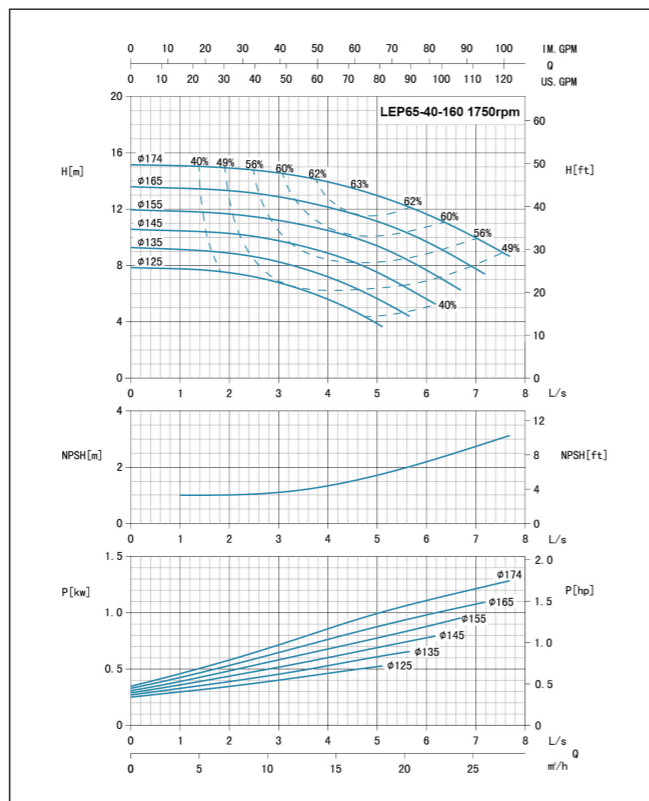
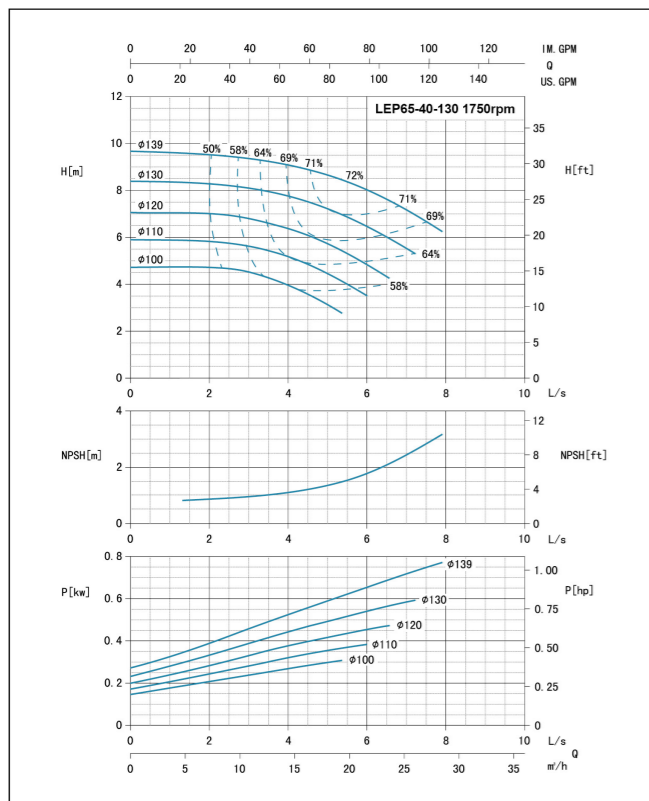
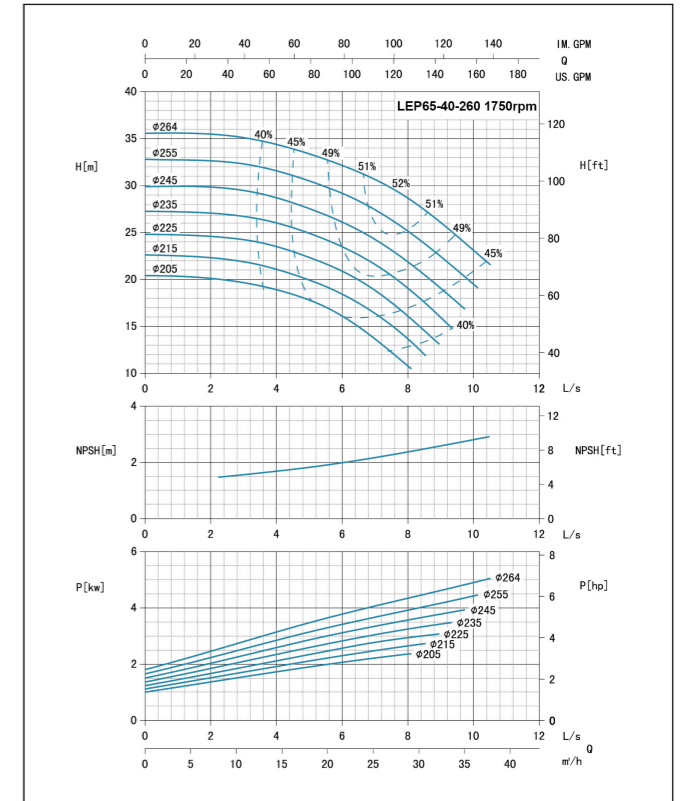
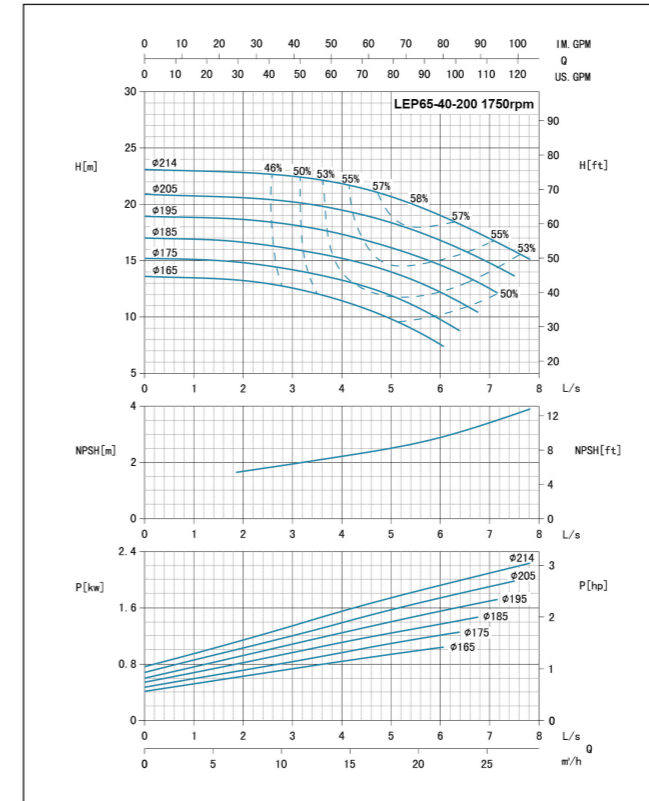
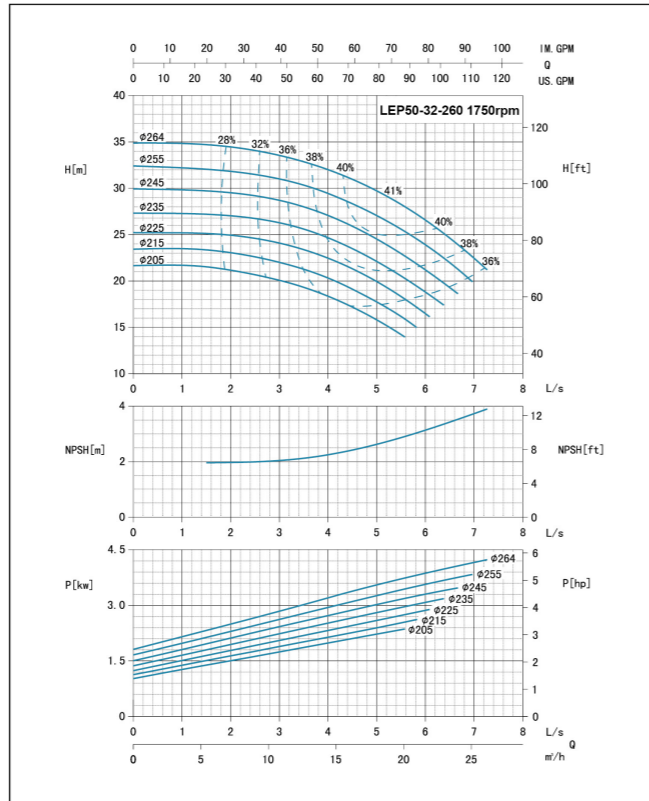
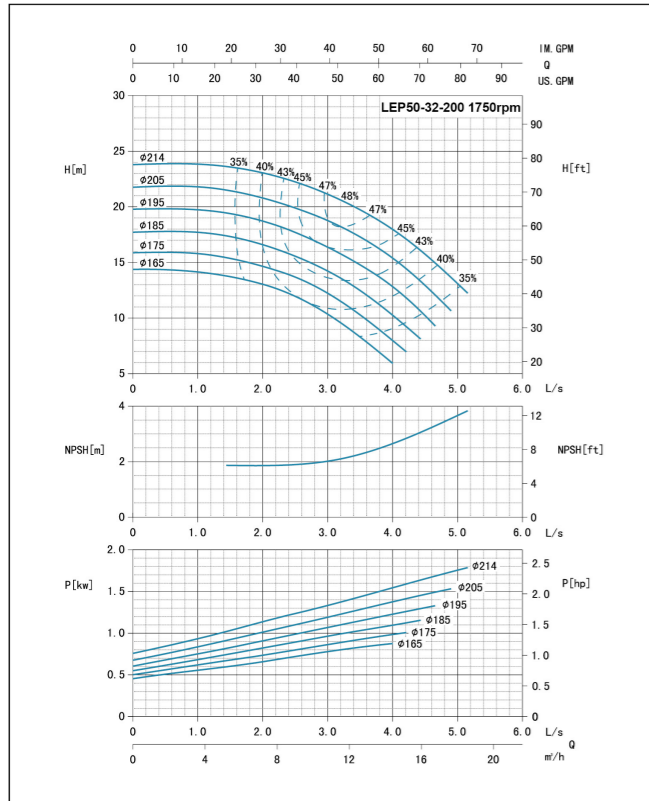

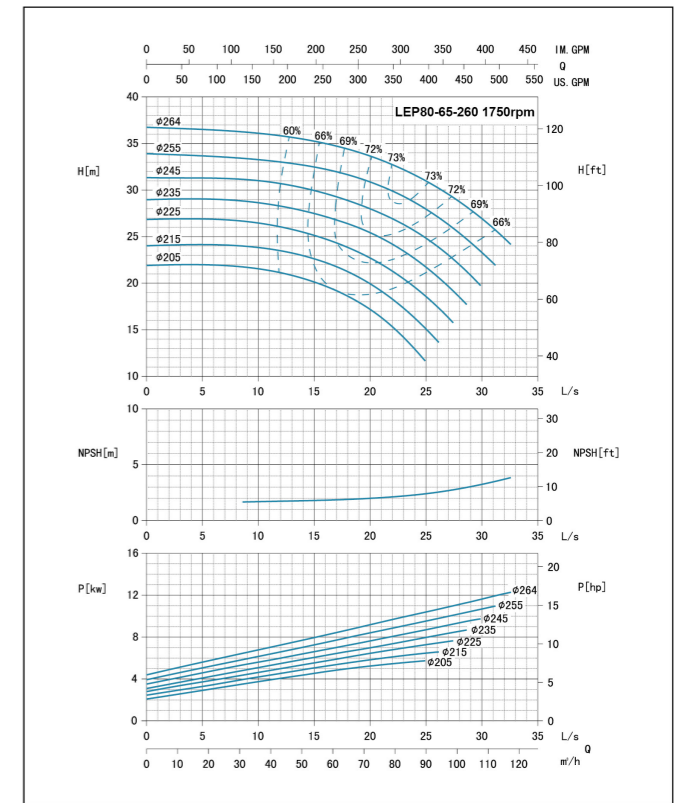
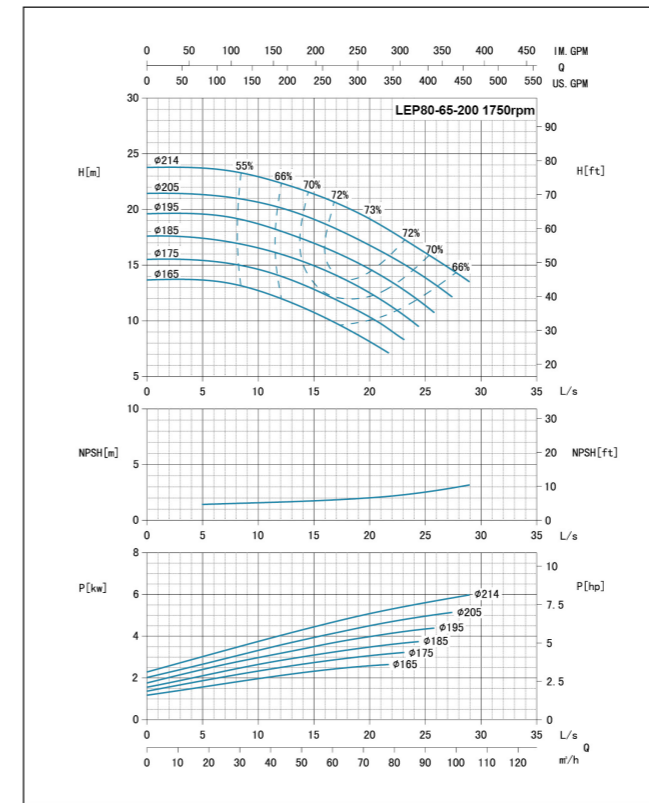
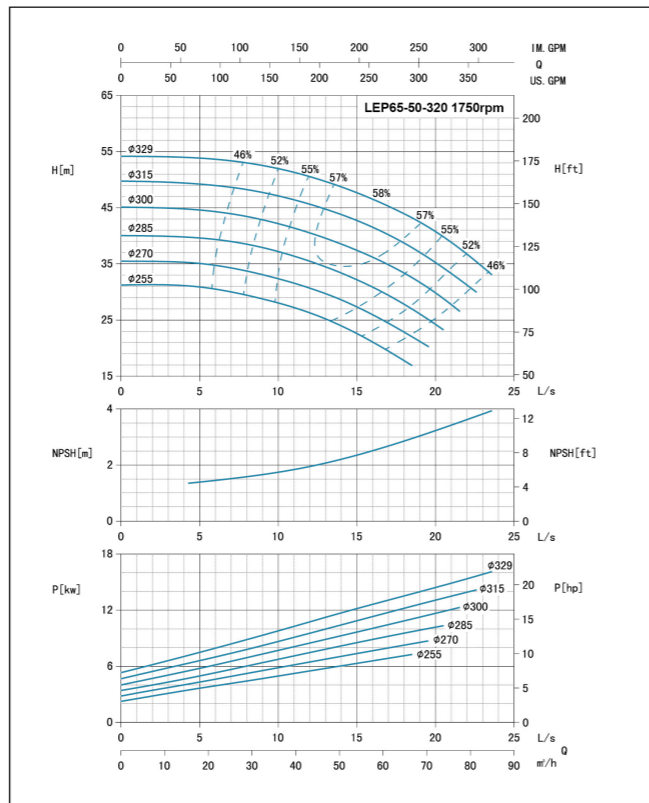
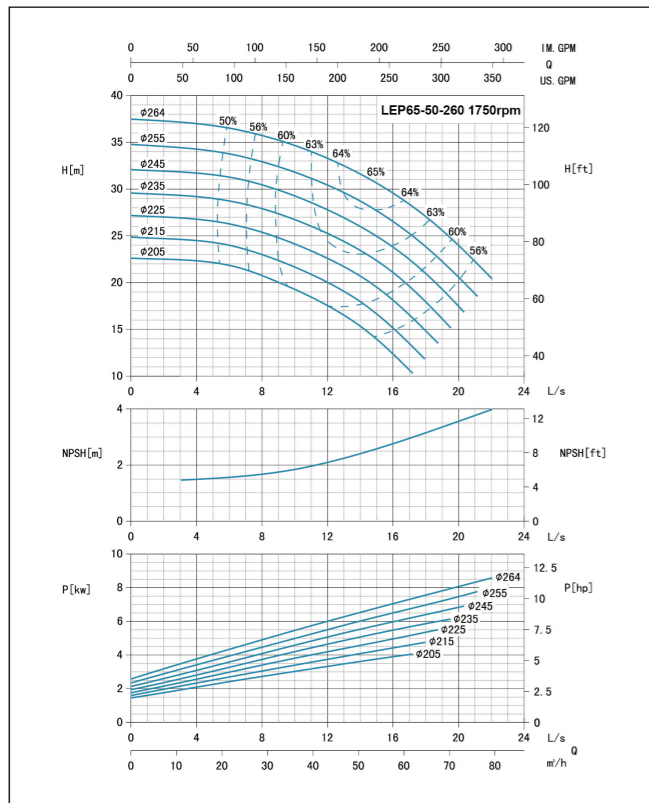
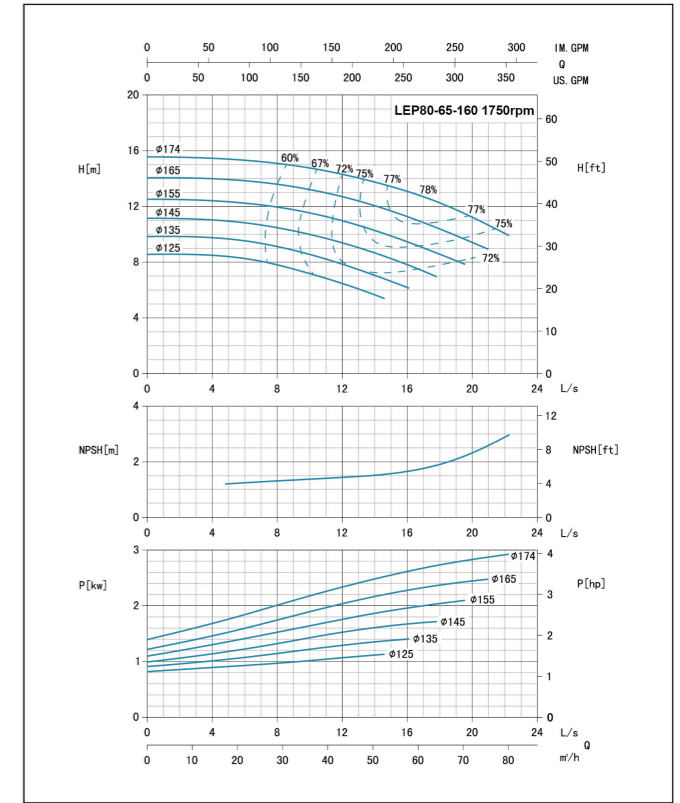
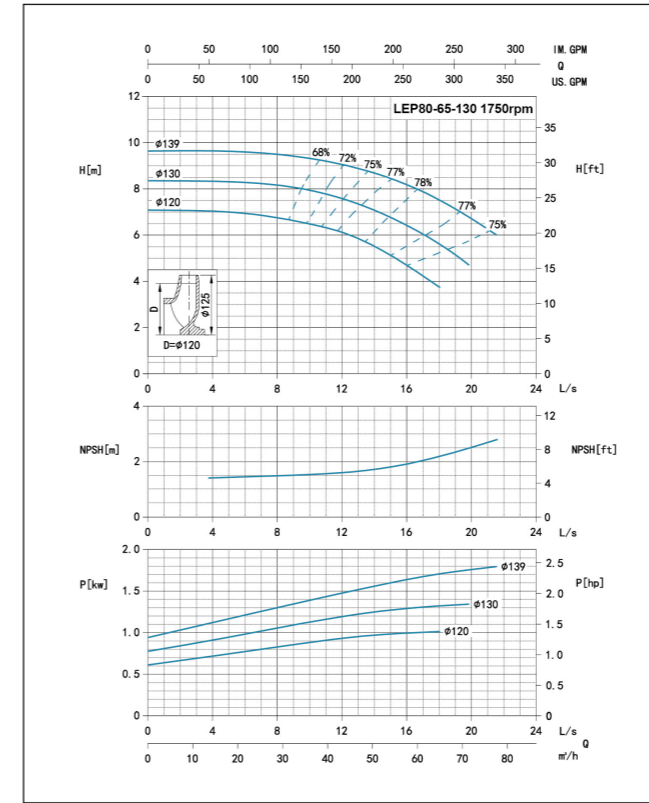
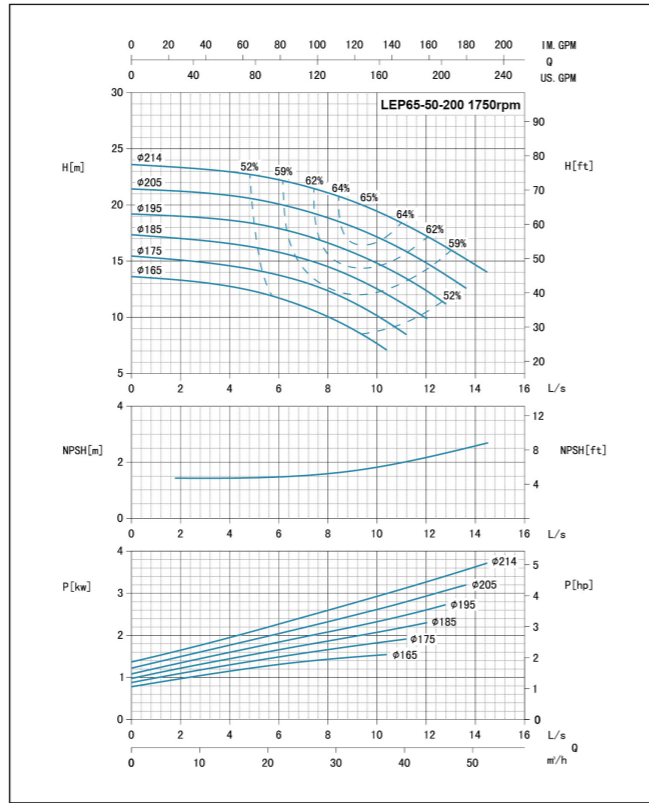
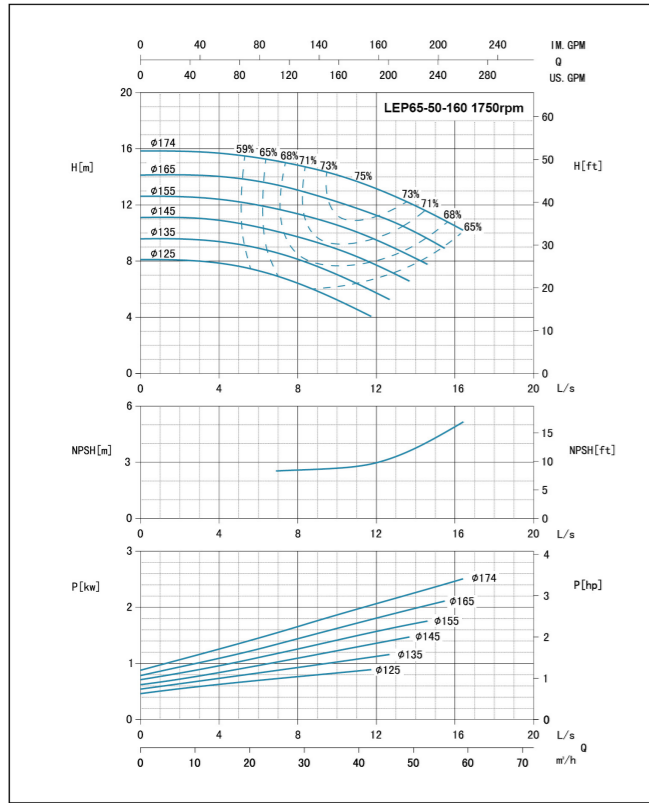

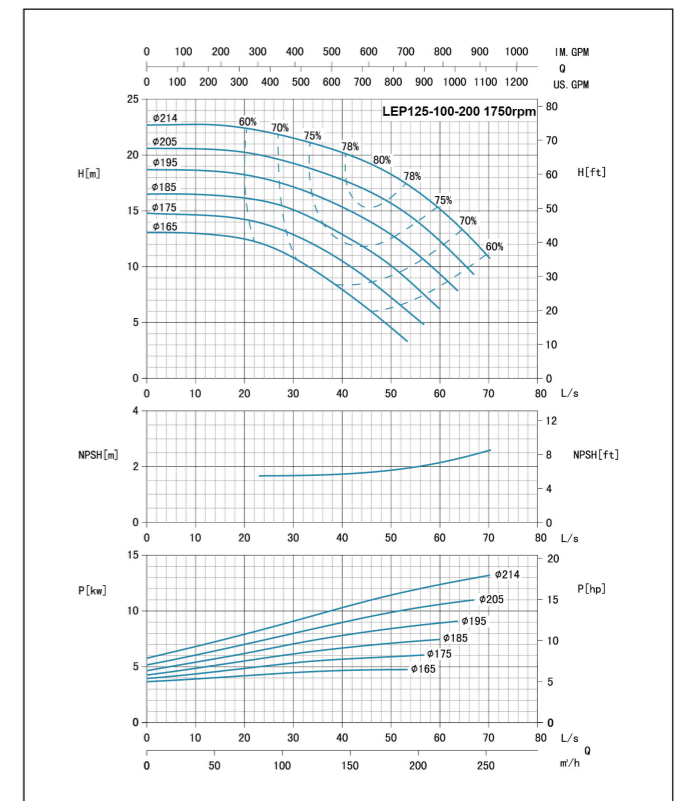
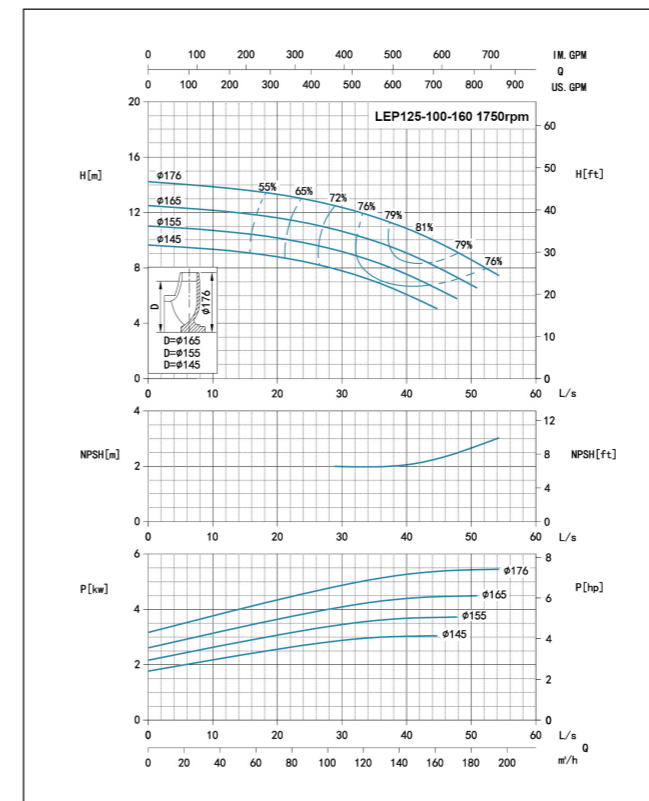
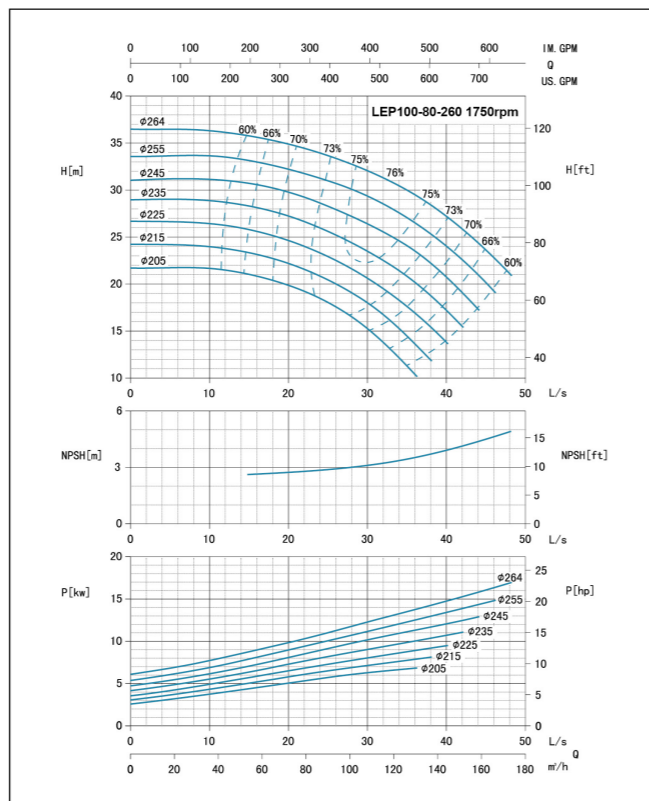
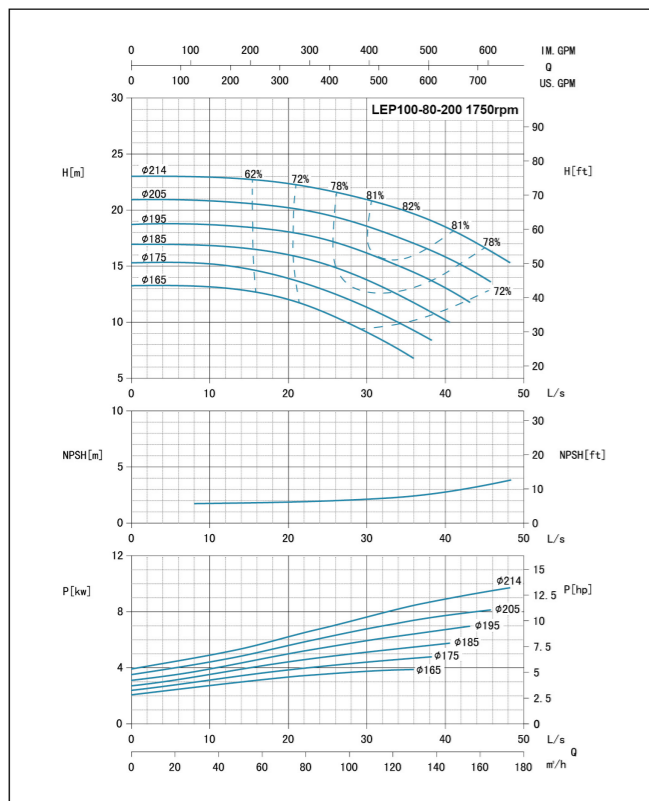
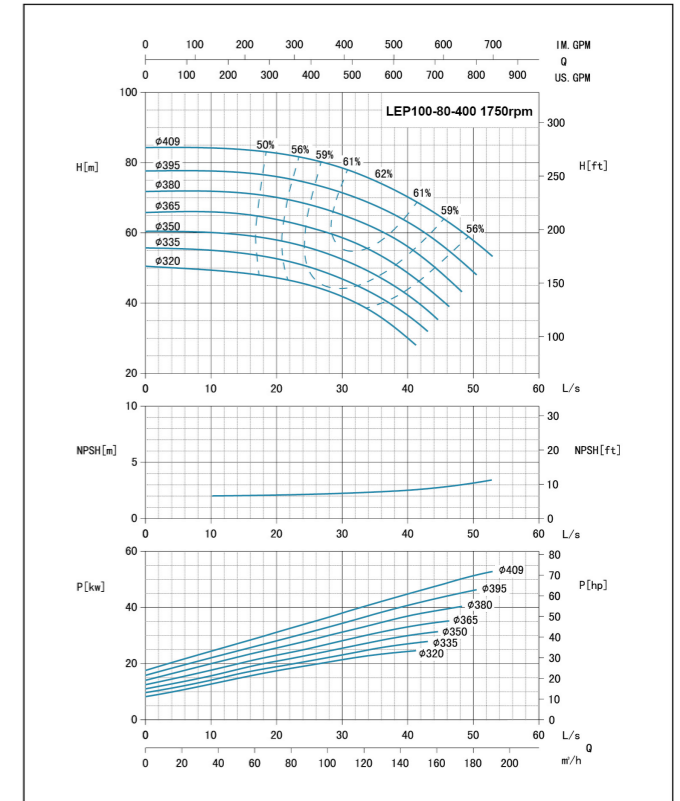
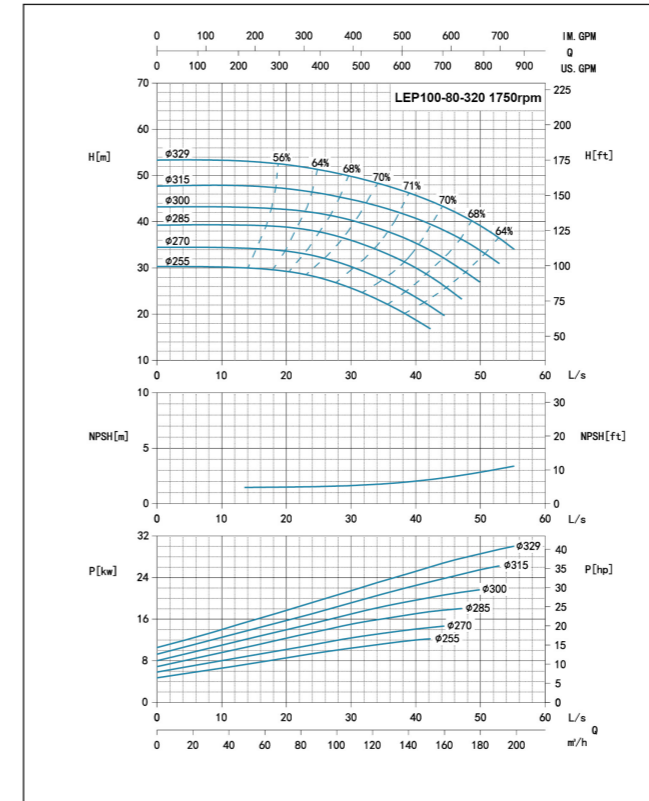
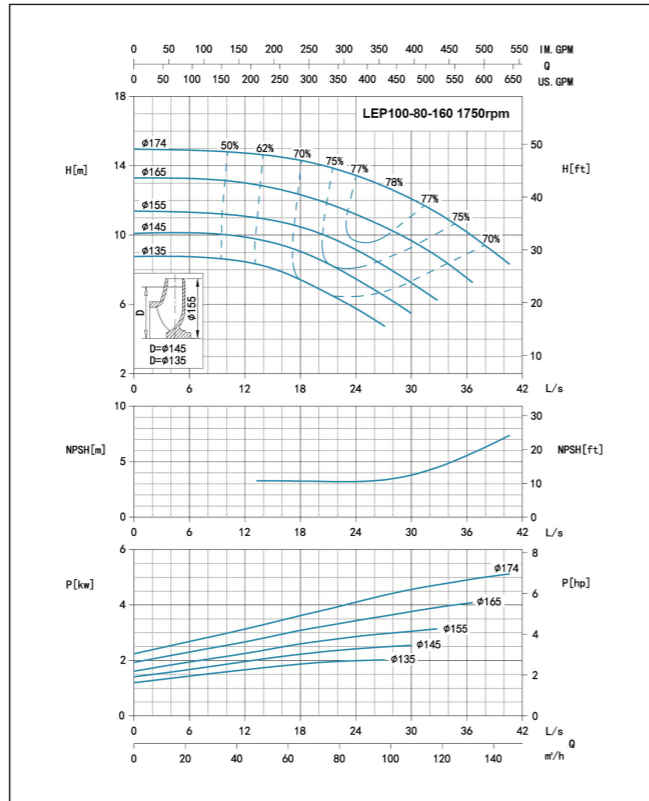
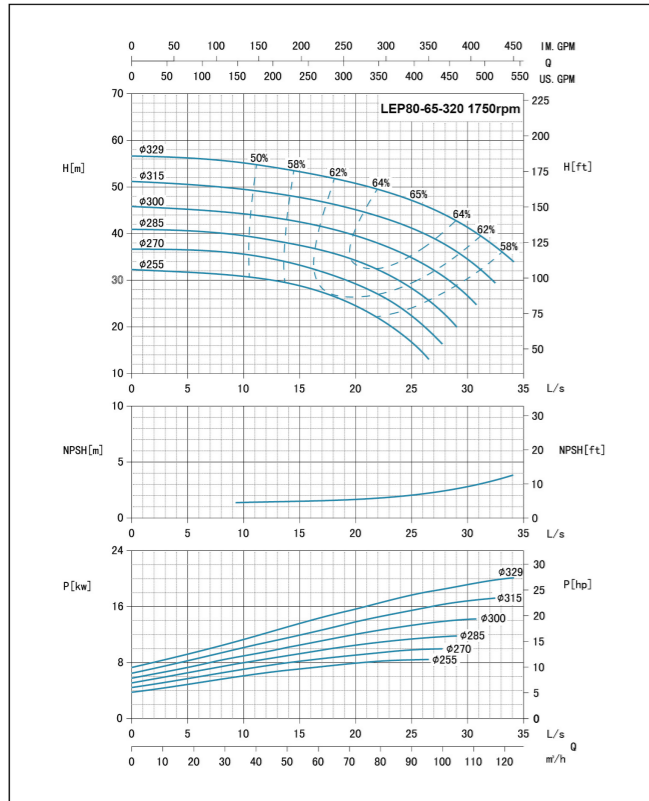

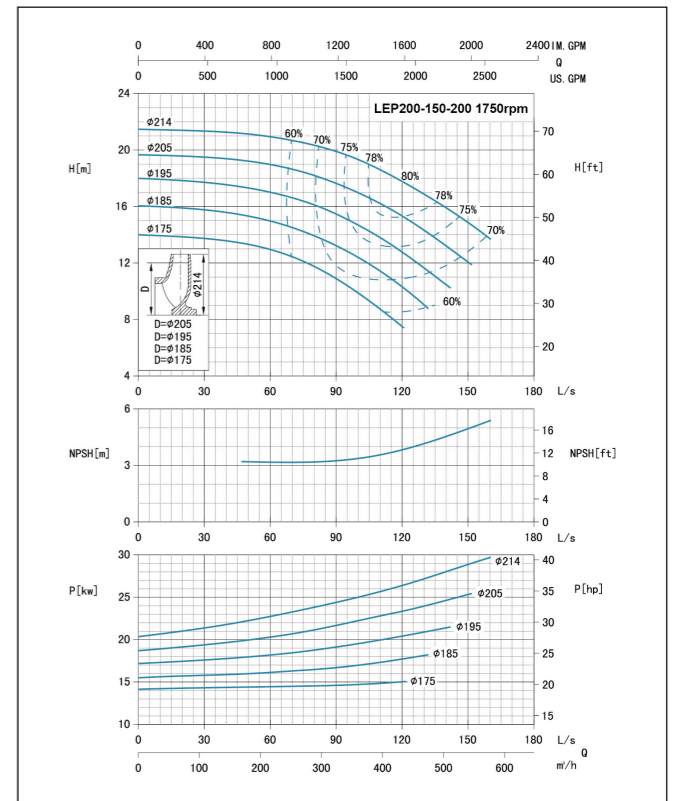
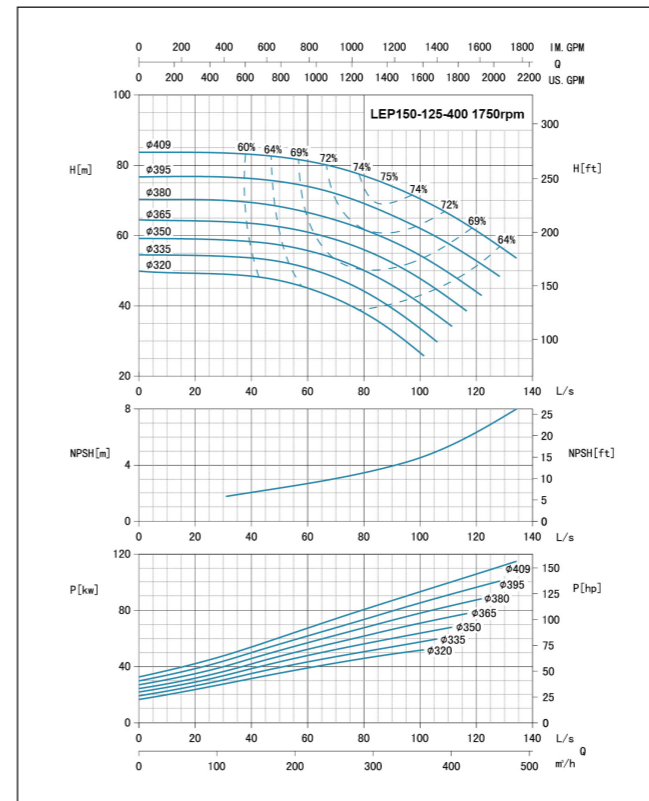
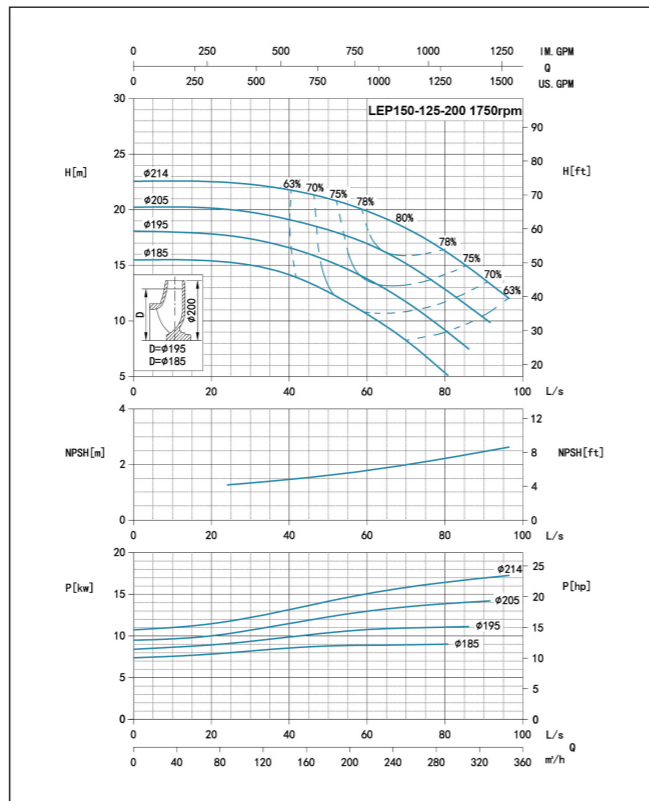
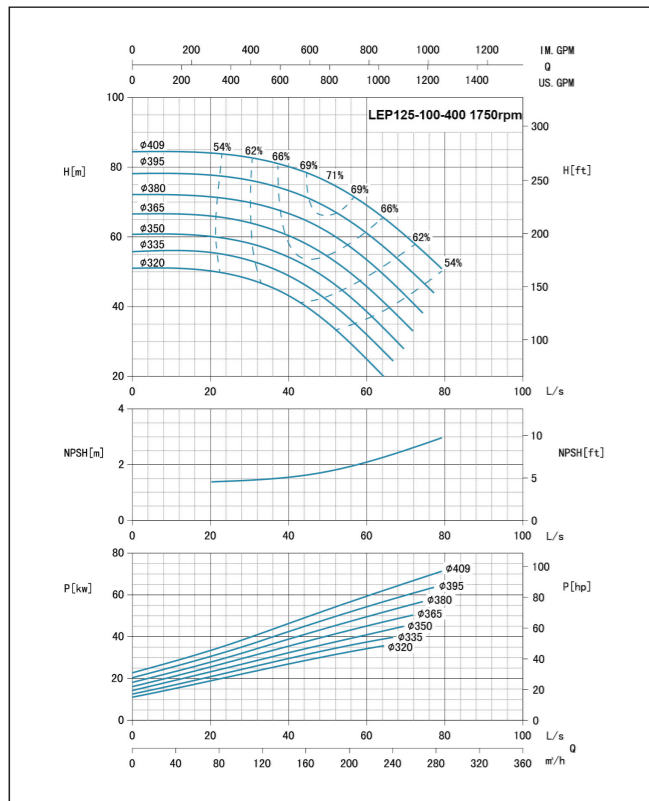
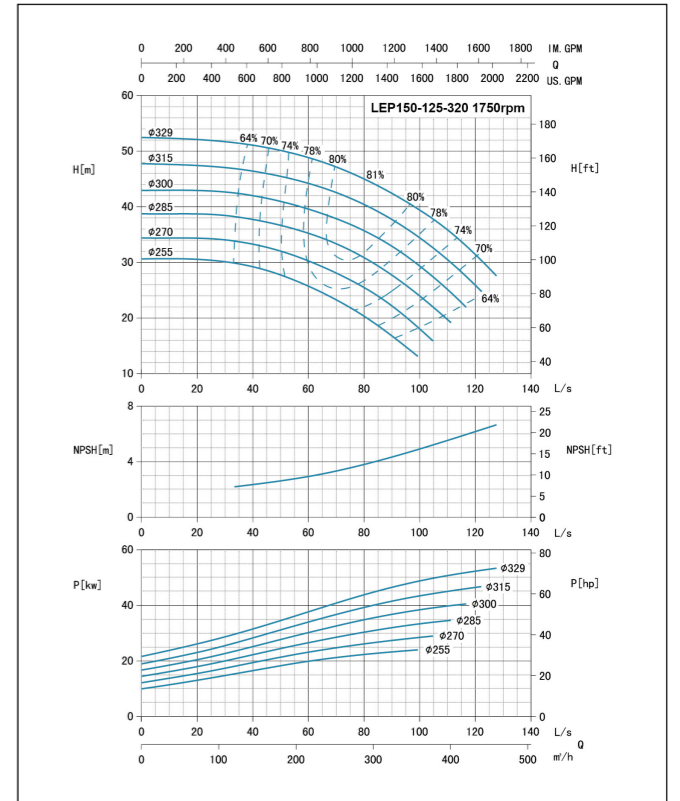
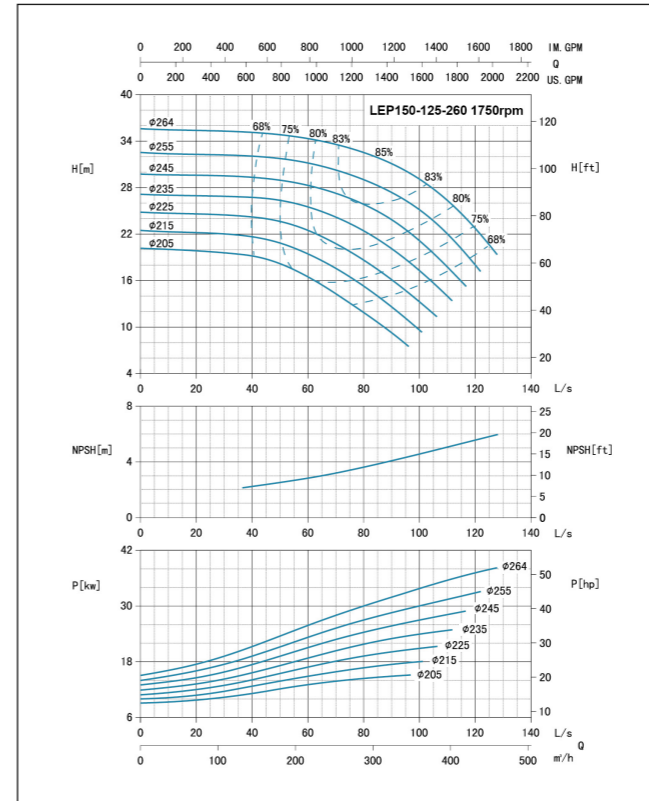
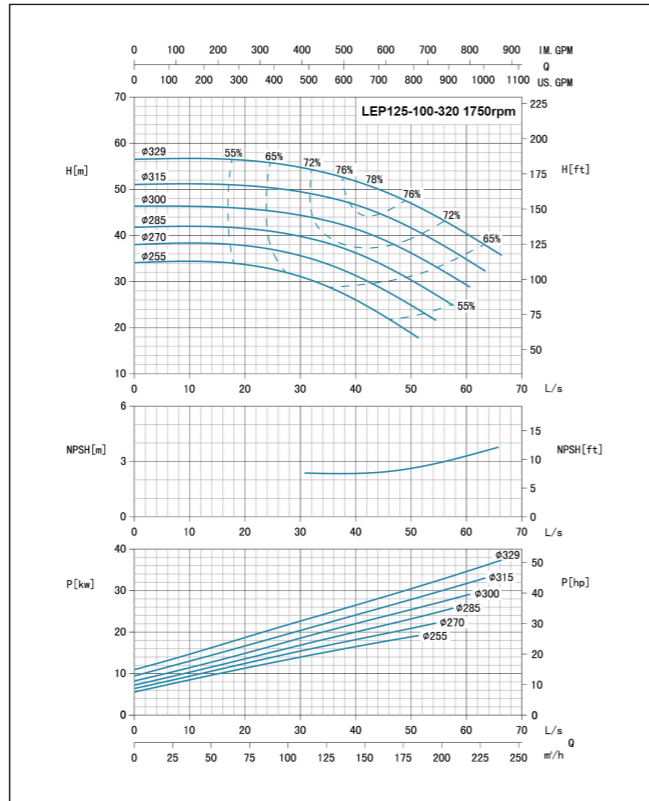
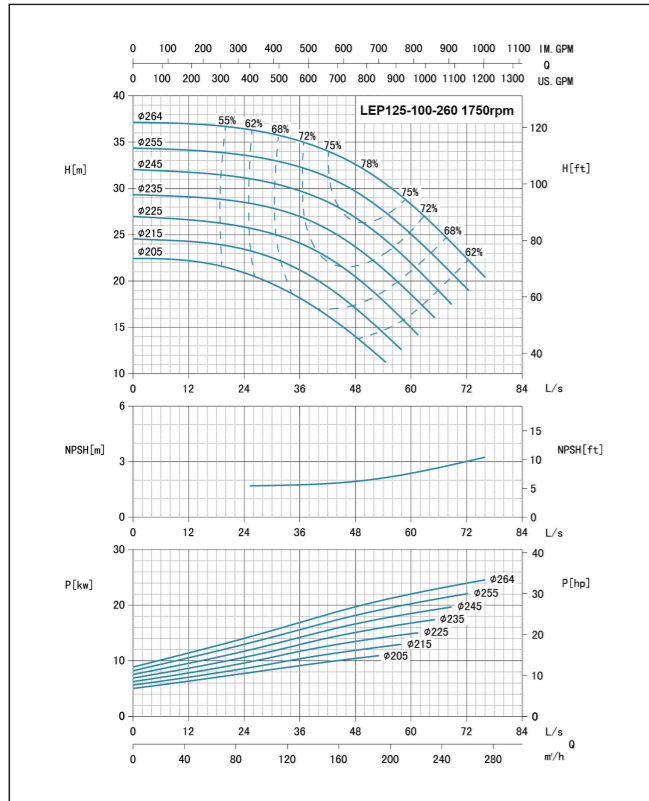

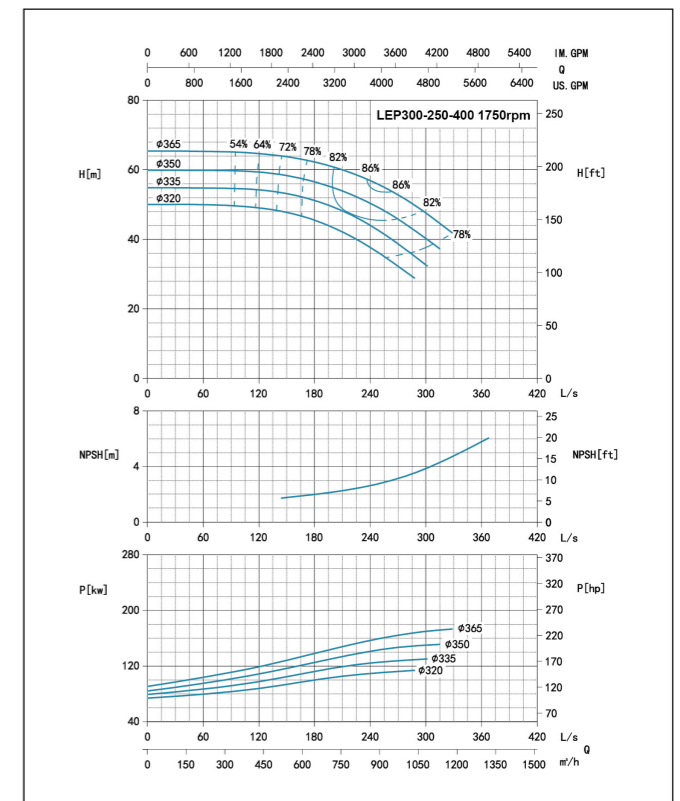
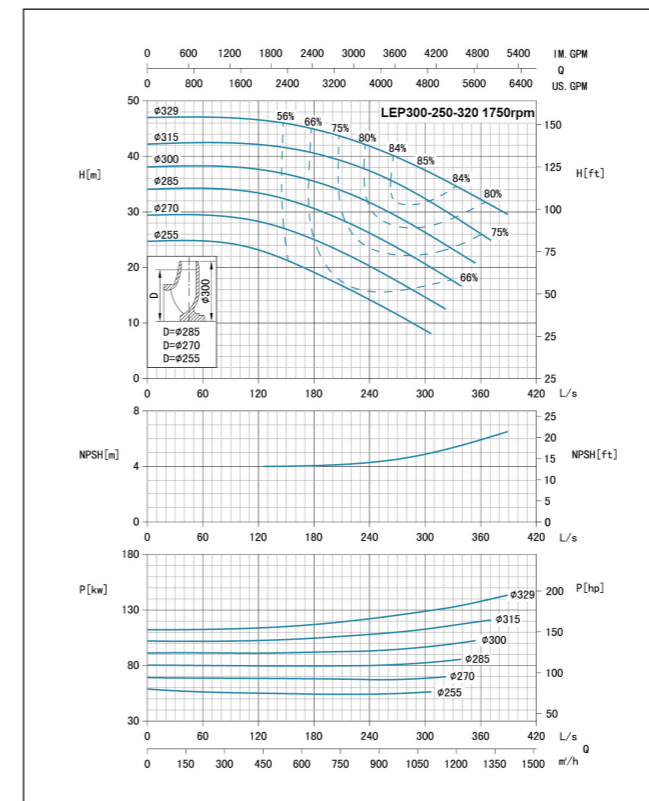
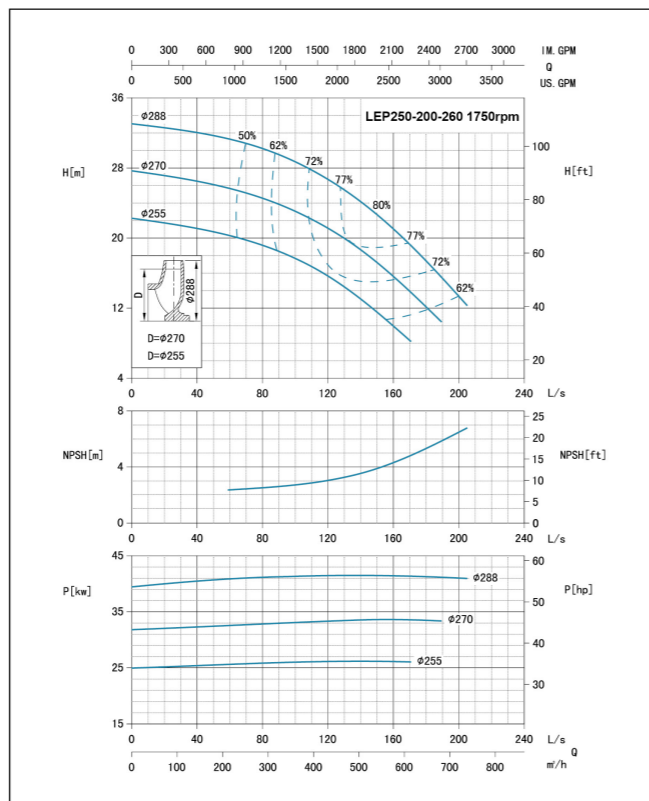
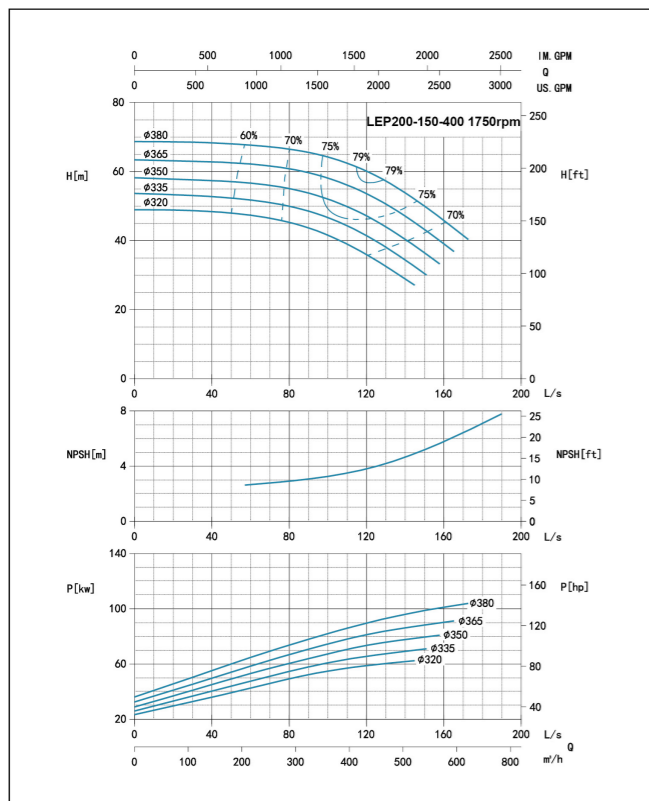
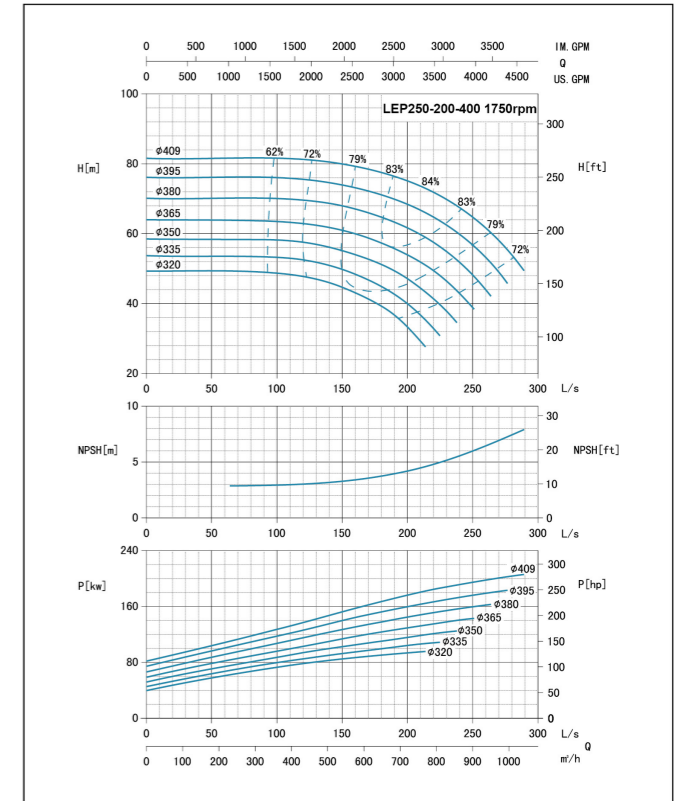
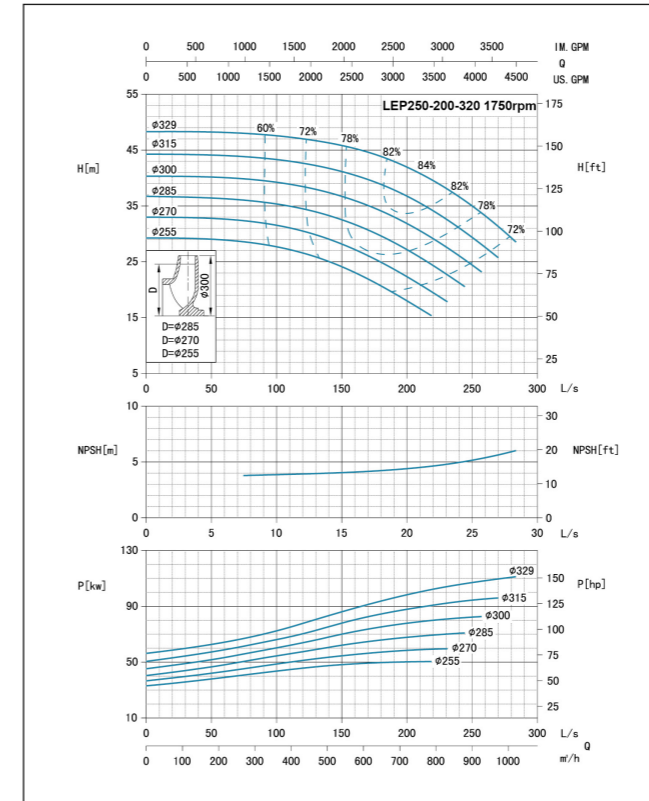
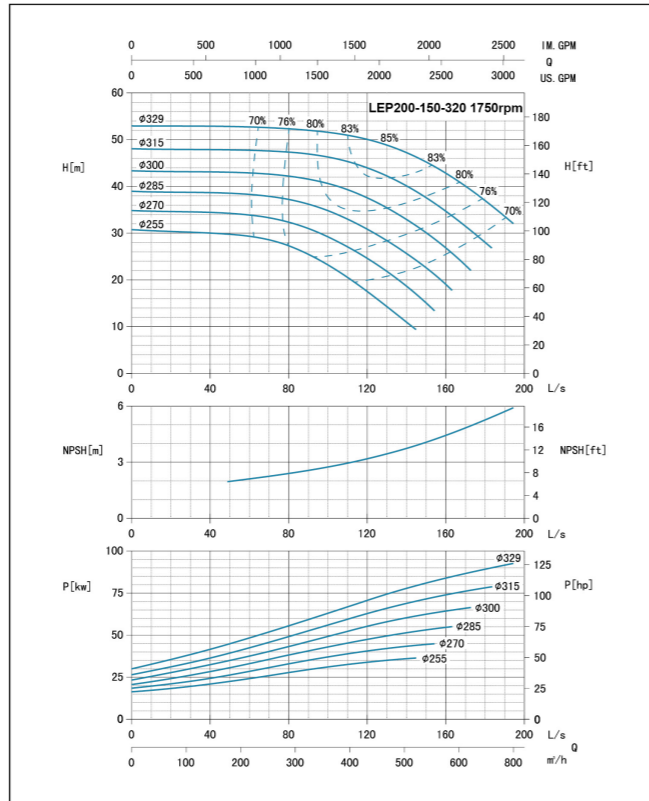
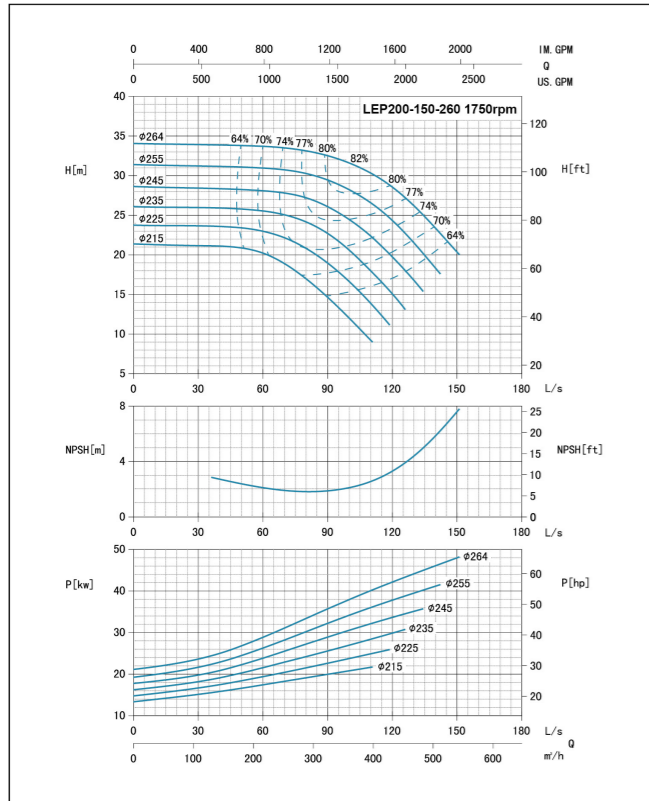

# Pump Range



● Peripheral Pump



● Self-Priming Peripheral Pump

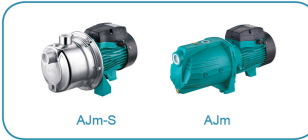

● Jet Pump



● Jet Pump for Deep Wells



● Centrifugal Pump



● Multistage Centrifugal Pump



● Self-Priming Centrifugal Pump



● Stainless Steel Multistage Centrifugal Pump



● Stainless Steel Centrifugal Pump

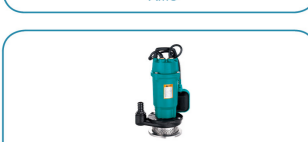

● Submersible Pump



● Stainless Steel Submersible Pump



● Stainless Steel Submersible Sewage Pump



● Flexible Shaft Pump



● Domestic Lifting Station



● Pool Pump



● Garden Submersible Pump



● Garden Jet Pump



● Pressure Booster System



● Fountain Pump



● Standard Centrifugal Pump



● Submersible Borehole Pump



● Gasoline/Diesel Water Pump



● Booster Pump/Circulation Pump

# Pump Range



● Submersible Sewage Pump



● Submersible Sewage Pump

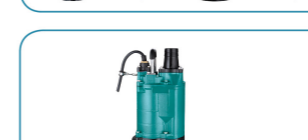

● Submersible Dewatering Pump



● Submersible Slurry Pump



● Stainless Steel Vertical Multistage Pump



● Stainless Steel Horizontal Multistage Pump



● Semi-open Impeller Stainless Steel Centrifugal Pump



● Stainless Steel Standard Centrifugal Pump



● Pressure Booster System



● Vertical In-line Pump



● Bare Shaft End Suction Centrifugal Pump



● End Suction Centrifugal Pump